

AC Magnetic Properties of Electrical Steel Sheet under DC-biased Magnetization

Abstract. AC magnetic properties of electrical steel sheets are generally evaluated under symmetrical alternating magnetization in the standard magnetic measurement. However, magnetizing conditions of electrical steel sheets in electromagnetic equipments are not always symmetric and alternating magnetization. This paper presents a measuring system for AC magnetic properties of electrical steel sheets under two-dimensional DC-biased magnetization and discusses the properties under DC-biased magnetization.

Streszczenie. Warunki magnesowania w urządzeniach elektromagnetycznych nie zawsze są symetryczne. W artykule zaprezentowano system do badania właściwości AC z możliwością podmagnesowania polem DC w obu osiach. (Właściwości magnetyczne AC blach elektrotechnicznych podmagnesowanych polem DC)

Keywords: magnetic measurements, two-dimensional DC-biased magnetization, electrical steel

Słowa kluczowe: pomiary magnetyczne, blachy elektrotechniczne.

Introduction

Electrical steel sheets are widely used as core materials for electromagnetic equipments, such as transformers and motors. The AC magnetic properties of electrical steel sheets are generally evaluated under symmetric alternating magnetic excitation. In recent years, the driving condition of the electrical equipments has been diversified according to development of the power electronics. The equipments may be driven by AC voltage with DC bias due to the imbalance of switching time of semiconductor devices. Therefore, the core material in the equipments is sometimes excited under AC magnetization with DC bias. The core material is also magnetized under two-dimensional magnetizing conditions such as rotational flux magnetization [1]. Typically, we have dealt with the DC-biased magnetization in the case that the direction of the DC magnetic induction is the same as the direction of the AC magnetic induction [2]. However, it is also important to understand the magnetic properties under DC-biased magnetization with different directions of AC and DC magnetic inductions. In this paper, a measurement system for magnetic properties of electrical steel sheets under the one- and two-dimensional DC-biased magnetization conditions is presented and the AC magnetic properties under DC-biased magnetization have been discussed.

Principle and Experimental Procedure

Fig. 1 defines the measuring quantities under DC-biased magnetization. B_m is the AC magnetic induction, ΔB is the DC-biased magnetization, and H_{DC} is the biased magnetic field. For magnetic properties under DC-biased magnetization, the AC and DC components of the magnetic induction B and the magnetic field H should be accurately evaluated.

Fig. 2 shows the three DC-biased magnetizing conditions dealt in this paper. The double arrow means the AC magnetization and the single arrow means the DC-biased magnetization. The DC-biased magnetizing condition usually means the case that the directions of the AC and DC magnetizations are the same as shown as the X-biased in Fig. 2. This one-dimensional condition is conventionally called DC biased magnetization. On the other hand, the directions of the AC and DC magnetizations are not always the same. The Y-biased in Fig.2 is the case that the directions of the AC and DC magnetizations are orthogonal, and 45-biased means the case that the angle between the directions of the AC and DC-biased

magnetizations is 45 degrees. These conditions are termed as the two-dimensional DC-biased magnetization. It is also important to understand the magnetic properties under the two-dimensional DC-biased magnetization.

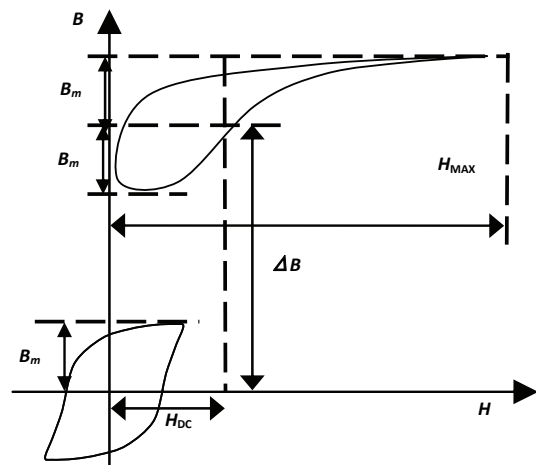

Fig.1. Definition of measuring quantities under DC-biased magnetization.

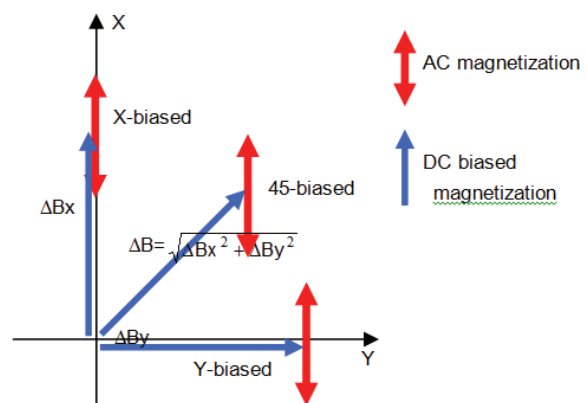

Fig.2. Three DC biased magnetizing conditions dealt in this paper.

Usually the principle of measurement for magnetic properties is shown in (1), (2), and (3).

$$(1) \quad B = \frac{1}{SN_B} \int v_B dt$$

$$(2) \quad H = \frac{1}{\mu_0 A} \int v_H dt$$

$$(3) \quad P = \frac{1}{\rho T} \int_0^T H \frac{dB}{dt} dt$$

where: B – magnetic induction, S – cross section area of sample, N_B – turn number of B sensing coil, H – magnetic field strength, μ_0 – magnetic constant, A – effective area of H sensing coil, v_B and v_H – output voltage from B and H sensing coils, P – specific total loss of sample, ρ – density of sample, T – magnetizing cycle. For two dimensional magnetic properties, the properties along the orthogonal two directions of X and Y have to be evaluated.

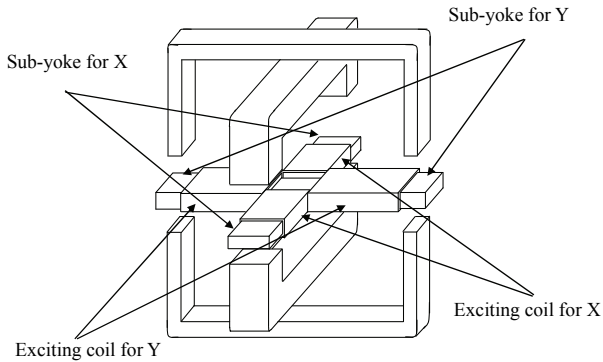

Fig.3. Magnetic exciting apparatus.

Fig. 3 shows a magnetic exciting apparatus for the two-dimensional DC-biased magnetization. Shape of samples is square and the samples are excited from two-orthogonal directions of X and Y. The exciting coils for each direction are consisted from AC and DC exciting coils.

Fig. 4 shows the block diagram of the measurement system. Sinusoidal voltage from the synthesizer is supplied to the AC exciting coil via the power amplifier. The DC power supply is employed as a DC current source for the DC excitation. The flux density B and the magnetic field

strength H are respectively obtained by integrating the induced voltage from the B and H coils. The induced voltage is converted to digital data by A/D and numerically integrated by the computer to obtain the AC component. For the DC components of B and H , firm integration after neutralization is needed. Therefore, the induced voltage is also integrated by using a highly stable flux meter and averaged over the AC excitation cycle to obtain the variation of the DC component after neutralization. Total properties can be obtained to add the AC and DC properties. Two sets of the exciting and the signal detection systems mentioned above are employed for two independent orthogonal directions.

Fig. 5 (a) shows the change of the magnetic induced voltage due to the DC-biased magnetization for the Y-biased magnetization in which the AC magnetizing frequency f is 50Hz. $F.F.$ in the figure means the form factor of the induced voltage. As the DC-biased magnetization ΔB_y increases, the AC magnetic induction B_{mx} decreases and the waveform becomes distorted. Therefore, magnetizing signal should be controlled. In recent years, digital feedback method has been applied for magnetizing signal control [3]. By using the digital method, neutralization process should be needed at every time when the magnetizing signal waveform is changed, and it is very laborious procedure. Therefore, the magnetizing signal control by using analogue feedback circuit has been employed in this paper. If the analogue control is fully complete, the neutralization has to be done only first once. Fig. 5 (b) shows the change of the magnetic induced voltage by the analogue feedback for the magnetizing signal control. The induced voltage has been kept better than the non controlled condition. Fig. 6 shows the change of the B_x - B_y loci due to DC-biased magnetization ΔB_y for non-controlled condition in Fig. 6 (a) and controlled condition in Fig. 6 (b). A little bowing of the locus is left after the magnetizing signal control. Therefore, the system for the magnetizing signal control should be improved in the future.

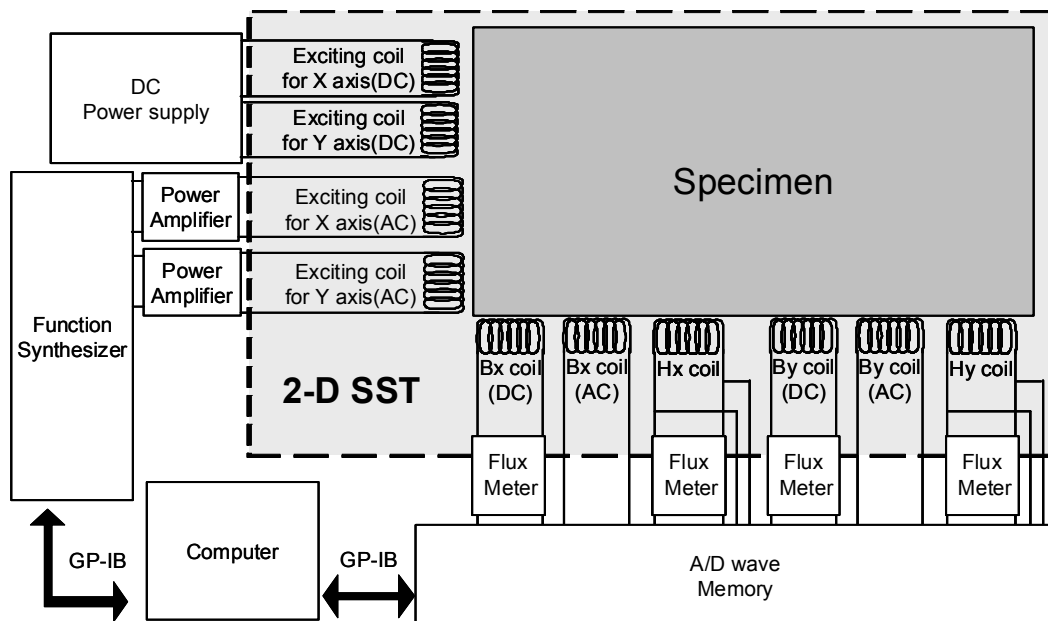

Fig.4. Block diagram of measurement system for magnetic properties under two-dimensional DC-biased magnetization.

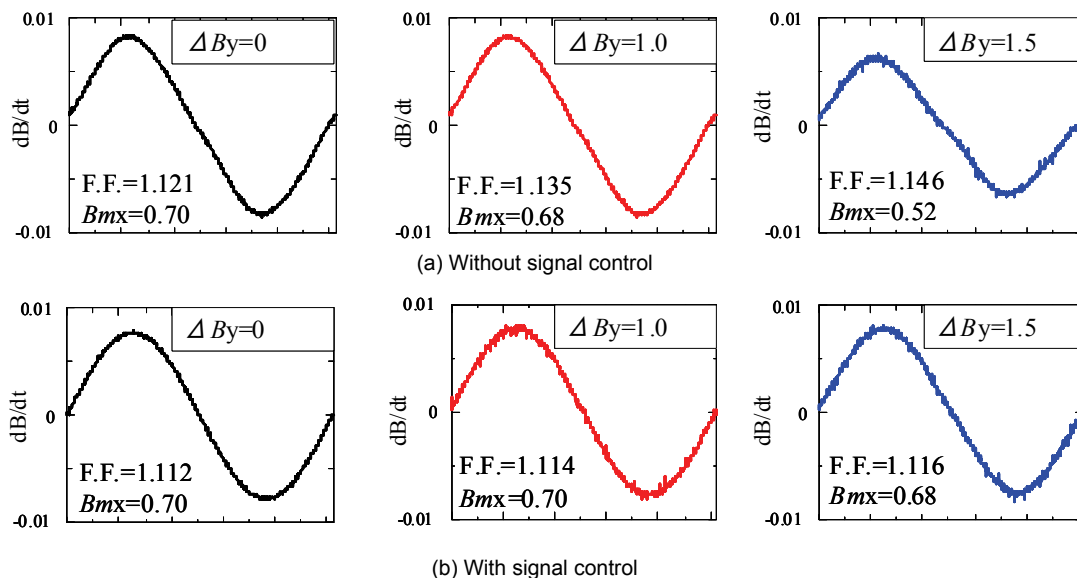

Fig.5 Waveform of dB/dt with and without magnetizing signal control.

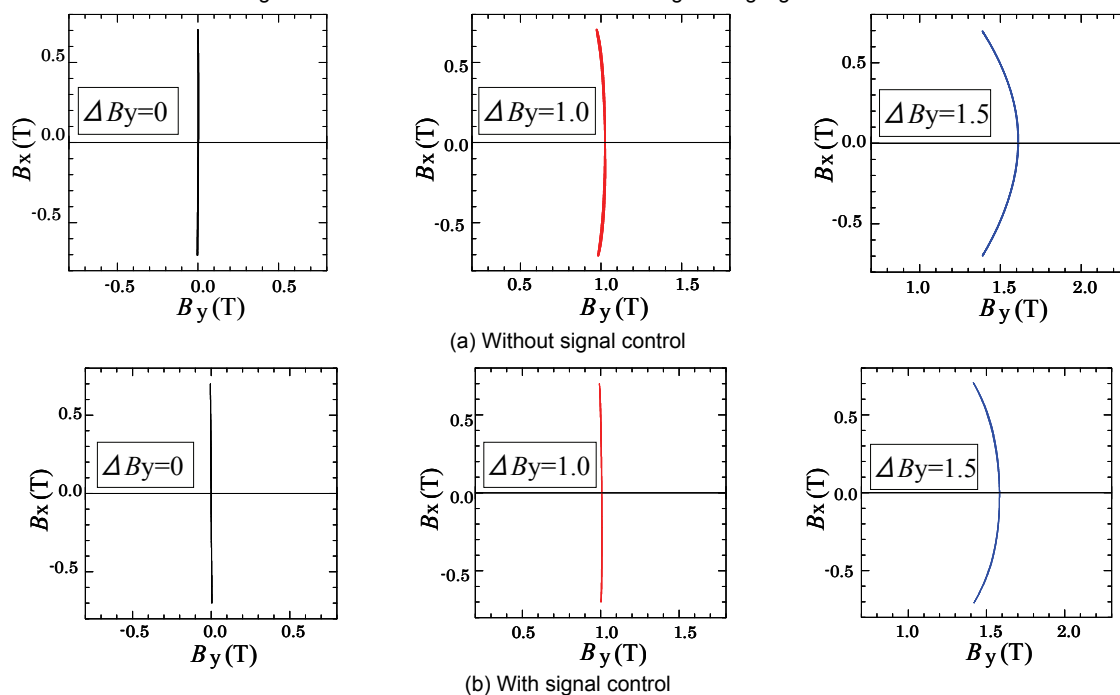

Fig.6 B_x - B_y loci with and without magnetizing signal control.

Results and discussions

A non-oriented electrical steel sheet has been measured under the DC-biased magnetization. The CCW/CW problem exists and very high accuracy is needed in sensing setup for B and H to evaluate the rotational magnetic properties in higher induction region [4]. The signal sensing setup used in this paper does not sufficiently have high accuracy, therefore only three alternating magnetic properties with DC bias as shown in Fig. 2 have been evaluated. The AC excitation frequency f is 50 Hz. Fig. 7 shows H_x - B_x hysteresis locus change due to ΔB_x under the X-biased magnetization. The locus was shifted and became asymmetric as the DC-biased magnetization ΔB_x increased. The peak position of each locus almost fitted to the H_m - B_m curve under symmetric alternating magnetization. This suggests that the neutralization process has repeatability and the biased quantity ΔB and H_{DC} can be accurately evaluated. Fig. 8 shows H_x - B_x hysteresis locus change due

to ΔB_y under Y-biased magnetization. In the case of Y-biased magnetization, the hysteresis locus kept symmetry with respect to the origin point but tilted as the biased magnetization increased.

Fig. 9 shows the change of the AC locus shape. In only the case of Y-biased, the shape kept symmetry with respect to the origin point. This is because that the actual maximum induction at $\pm B_m$ is the same value of $\sqrt{\Delta B_y^2 + B_m^2}$ in the Y-biased condition but is the different value $\Delta B_x \pm B_m$ in the X-biased. In this paper, X-direction is kept to the rolling direction of the steel sheet. If X-direction is not symmetrical axis of magnetic anisotropy, the symmetrical shape of hysteresis loop may have not been obtained.

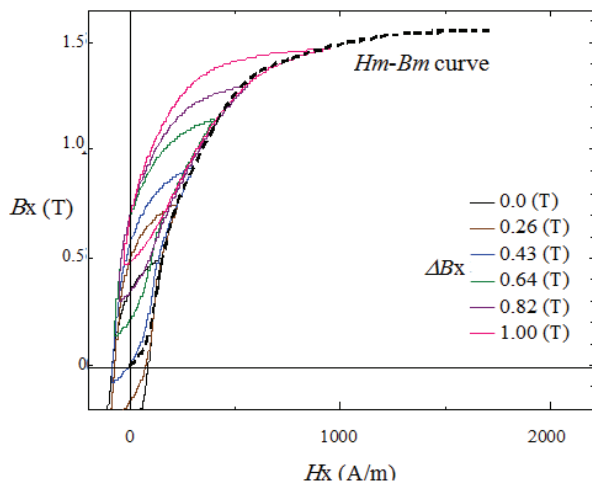

Fig.7 Variation of AC hysteresis loops along X-direction due to the parallel DC-biased magnetization, ($B_{mx} = 0.5T$, $f = 50Hz$).

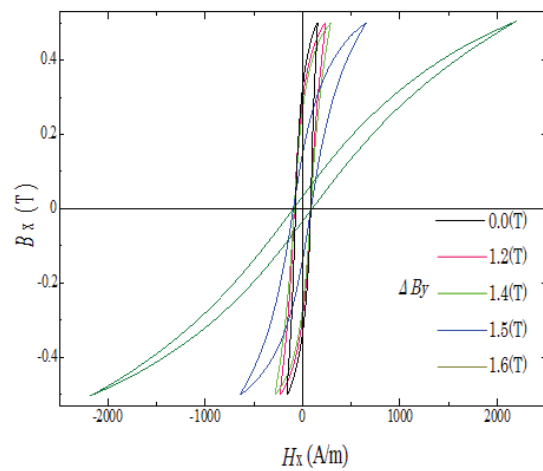

Fig.8 Variation of AC hysteresis loops along X-direction due to the perpendicular DC-biased magnetization, ($B_{mx} = 0.5T$, $f = 50Hz$).

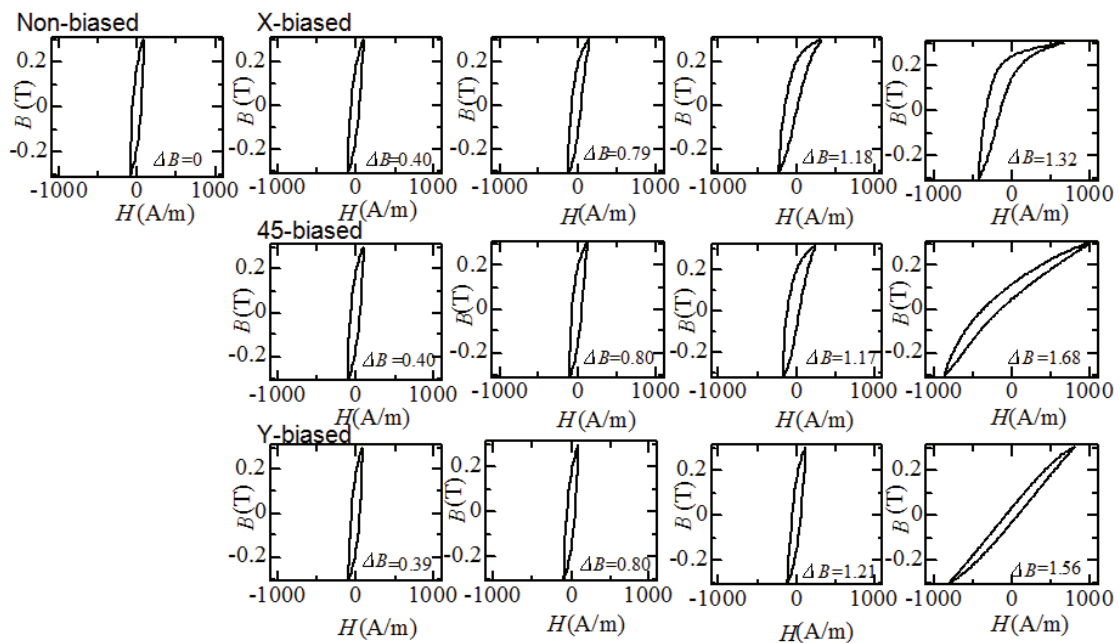

Fig.9. Locus shape change due to DC-biased magnetizing conditions when $B_{mx} = 0.3T$, $f = 50Hz$.

Fig. 10 shows the change of the AC magnetic permeability due to the DC-biased magnetizations. In higher magnetic biased region under the Y-biased condition, the magnetizing process becomes magnetic rotation at the overall magnetic cycle. Therefore, the magnetic permeability decreases. The specific total losses increased due to the DC-biased magnetizations as shown in Fig. 11. The losses increased with DC-biased magnetization in all the three conditions. This is qualitatively explained by using Fig. 12. In the case of the X-biased condition with AC magnetization when $B_m = 0.5T$ and $\Delta B_x = 1.0T$, the maximum magnetization is 1.5T and the minimum magnetization is 0.5T. Magnetic wall movement is therefore main process in the lower induction. In the higher magnetic induction, disappearance and generation of magnetic walls occur and magnetic rotation becomes main magnetizing process. Therefore, the magnetic permeability decreases and the specific total loss increases. On the other hand, in the case of the Y-biased condition when $B_m = 0.5T$ and $\Delta B_y = 1.0T$, the maximum magnetization is about 1.1T and the

minimum magnetization is 1.0T. Magnetic wall movement is main process in all the magnetizing cycle. Therefore, the magnetic permeability is kept to be a high value. When $\Delta B_y = 1.6T$, maximum magnetization is about 1.7T and the minimum magnetization is 1.6T. Magnetic rotation becomes main process in all the magnetizing cycle. Therefore, the magnetic permeability decreases. In the higher biased magnetization in Y-biased, the magnetizing process almost becomes magnetic rotation and losses may decrease like the rotational magnetic losses in higher induction.

We have now evaluated only limited magnetic conditions. The magnetic properties changed due to the magnetizing process. Therefore, the relationship between H_{DC} and ΔB may be different in the ascent and descent of DC bias. We should advance the examination of the magnetic characteristic under more wide-ranging biased condition in the future.

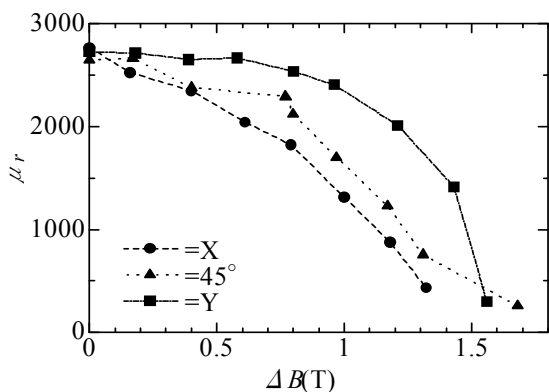

Fig.10. Variation of AC relative permeability due to DC-biased magnetizing conditions.

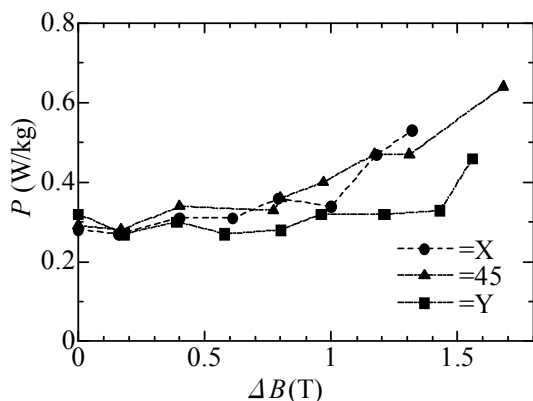

Fig.11. Variation of AC specific losses due to DC-biased magnetizing conditions.

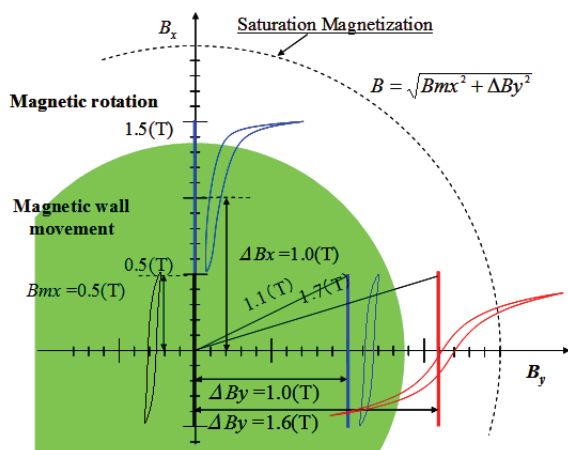

Fig.12. Relation between shape of loops and the magnetizing process.

Conclusions

The measuring system for the magnetic properties of electrical steel sheets under the two-dimensional DC-biased magnetization has been constructed and the AC magnetic properties under alternating induction with DC bias have been measured. The specific losses increased with the increasing the DC-biased magnetization up to middle range of induction. In the future, the measuring system should be improved to apply for the higher magnetic induction, and the magnetic properties under various DC-biased magnetizing conditions would be discussed in detail. We also expect that the database of magnetic properties under the DC-biased magnetizing conditions would be utilized for new applications.

Acknowledgments

This work was supported by the Japan Science and Technology Agency (JST)/ Oita Prefecture Collaboration of Regional Entities for the Advancement of Technological Excellence.

REFERENCES

- [1] K. Mori, S. Yanase and Y. Okazaki, New 2D magnetic measurement method using vertical yokes with slits, *Przeglad Electrotechnology*, 81. No.5, (2005), 24-26
- [2] S. Yanase, Y. Okazaki and T. Asano, *J. Magn. Magn. Matr.*, 215-216, (2000), 156-158
- [3] G. Bertotti, E. Ferrara, F. Fiorillo and M. Pasquale, *J. Appl. Phys.*, Vol. 73, No. 10, (1993), 5375-5379
- [4] T. Todaka, Y. Maeda and M. Enokizono, Counterclockwise/clockwise rotational losses under high magnetic field, *Przeglad Electrotechnology*, 85. No.1, (2009), 20-24

Authors: Dr. Shunji Yanase, Gifu University, Yanagido 1-1, Gifu, 501-1193, Japan, E-mail: takada@gifu-u.ac.jp; Prof. Yasuo Okazaki, Gifu University, Yanagido 1-1, Gifu, 501-1193, Japan, E-mail: okazaki@gifu-u.ac.jp