

Comparative study of electromagnetic and electronic ballasts - an assessment on harmonic emission

Abstract. In this paper, several high power lighting networks based on high pressures sodium (HPS) lamps with rated lamp powers of 70, 150 and 250 W have been set up. Those lamps have been studied with both electromagnetic and dimmable electronic ballasts, which can dim the lamp output smoothly and uniformly. Lamps connected to electronic equipment have been tested with different levels of power using dimming for a 220 V power supply. HPS lamps have been chosen because they are used in public lighting. This paper focuses on the harmonic characterization of modern HPS lamps connected to both types of devices. Harmonics under full and reduced power for several HPS lamps have been measured. It presents an investigation on the attenuation effect and a proposal of an index called the equivalent lamp index to characterize this effect on HPS lamps. Also it is concluded that using a combination of HPS lamps can result in a reduction of the current distortion.

Streszczenie. Analizowano system oświetleniowy wykorzystujący lampy sodowe. Badano lampy obciążone układami elektronicznymi i elektromagnetycznymi do sterowania jasnością. Zmierzone zawartość harmonicznych przy pełnej i ograniczonej mocy. Zaproponowano metody redukcji zniekształcenia prądu. (Studium porównawcze obciążenia lamp sodowych układami regulującymi oświetlenie – ocena zawartości harmonicznych)

Keywords: Lighting; Electronic ballasts; Electromagnetic ballasts; Harmonic Current; HPS lamps.

Słowa kluczowe: oświetlenie, zawartość harmonicznych, lampy sodowe.

Introduction

The Public Lighting Systems in our cities are a basic and vital service for city councils and other public administration. On the one hand, citizens demand high quality service in accordance with our high development society. On the other hand, a lighting installation is an important energy consumption source that is affected by factors such as regulation and maintenance. A recent study carried out for the European Commission has shown that between 30% and 50% of electricity used for lighting could be saved investing in energy-efficient lighting systems. In most cases, such investments are not only profitable but they also maintain or improve lighting quality [1]. The main recommendation is that streetlights and other outdoor lighting should be made more efficient as part of a comprehensive strategy to reduce CO₂ emissions including cleaner options for electricity generation, vehicle emissions, more energy efficient buildings, and smart electric meters combined with smart appliances which shift electricity use from peak to off-peak periods [2].

It is highly recommended the suitable election of the lamp. The majority of light sources used in public lighting are HID (High Intensity Discharge) lamps. The minimum acceptable requirements for lighting controls are that they provide enough light for the users of a space, avoid waste and reduce lighting levels without compromising users' satisfaction and productivity. Therefore, by having a good understanding of the lamps, ballasts, luminaires and control options available today, lighting can be produced so that it is energy efficient, cost effective and yields a better quality of light [3].

The following measures are recommended for decreasing electrical energy consumption afferent to the public lighting [4]: first, reduction of the luminance level (dimming) on the duration of the hours with reduced traffic, through the decrease of the feeding voltage of the lamps; second, street classification compliant with international standards and the establishment of the light technical parameters based on this classification; and third, proposal to adopt a special price for the electric energy destined for public lighting, due to the consumption on duration of the night.

Results show that it is important to encourage the installation of smart dimmable electronic ballasts which must be among other things: able to auto-detect lamp and electrical failures; able to measure and send power quality

data; and able to receive switch and dimming commands from a streetlight segment controller.

Thus, the most important savings could be achieved with the installation of a centralized SCADA, which can be used to monitor failed lamps and report their location in addition to the age and condition of every lamp. Consequently, maintenance expenses could be minimized by considering the remaining life of nearby lamps that might be replaced during the same service call. Finally, data collected by the SCADA that tracks the hours of illumination for each lamp can be used to claim warranty replacement, establish unbiased product and supplier selection criteria, and validate energy bills for the system. Communicating with lighting controls requires software protocols; however it is difficult to develop a whole system approach to lighting controls compatible to all the components. Usually, communication protocols require a separate set of communication wiring, which adds cost to lighting control systems. Fig. 1 illustrates a schematic of the experimental setup which is based on the LONWorks Power-Line communications (PLC) protocol that supports a large number of media which makes integration with complex traffic management and geographic information systems easier.

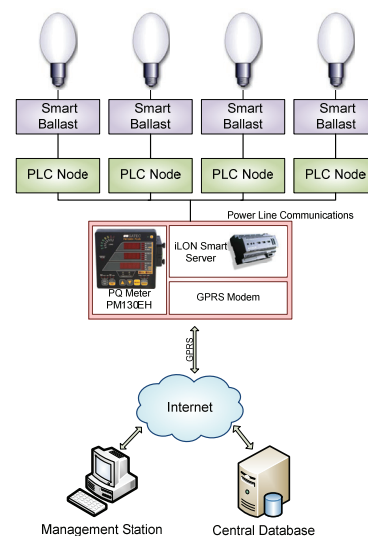

Fig. 1. Monitored Streetlight Networks. Schematic of the experimental setup.

Nowadays, the main concern is that lamps produce harmonics on lighting networks depending on control gear quality and lamp age. The attenuation effect of many devices has been documented in several studies. Some of them have characterized this effect by using EMTP simulation or experimental tests. Recent researches have shown the harmonic attenuation effect of Compact Fluorescent Lamps (CFLs) [5], [6], [7] and [8] among others. Nevertheless, only a few numbers of authors have decided to study this effect over HPS lamps [9]. This paper presents a good understanding of the HPS lamps harmonic and the attenuation of harmonic currents, based on experimental tests with these kinds of lamps using electromagnetic and electronic ballasts.

The remainder of the article is organised as follows: Section II outlines the background where it is explained the basis of the article. Results of an experiment with electromagnetic and electronic ballasts are shown and explained in sections III and IV. Section V compares the results obtained in both experiments. In section VI it is analysed the harmonic attenuation in the experiment with electronic ballasts. Section VII concludes.

Background

A number of compatibility problems have occurred in the field of lighting as a result of installing electronic ballasts without understanding how to avoid such problems. Examples of the problems that have occurred include [10]:

- Early failure of ballasts and lamps
- Early failure of occupancy sensors
- Malfunctions of energy management systems
- Malfunctions of centralized clock systems
- Malfunctions of infra-red-based consumer electronic devices
- Malfunctions of personal electronic devices such as a hearing aid.

Lighting also affects the Power Quality (PQ) of the electrical distribution system. PQ is concerned with deviations of the voltage or current from the ideal single-frequency sine wave of constant amplitude and frequency. A consistent set of definitions can be found in [11]. Poor PQ is a concern because it wastes energy, reduces electrical capacity, and can harm equipment and the electrical distribution system itself. Power quality deterioration is due to transient disturbances (voltage sags, voltage swells, impulses, etc.) and steady state disturbances (harmonic distortion, unbalance, flicker). This paper is focused on the second group, and, specifically on harmonic distortion [12].

The main objective must be to provide guidelines for minimizing any PQ impacts resulting from application of energy-saving technologies with regards to lighting. The primary focus is electronic ballast-driven HPS lamps for lighting. However, energy savings is often used as one of the selling features for these devices and customers need to have a clear understanding of the energy-saving potential of these types of technologies.

Concretely, harmonic analysis is a primary matter of PQ assessment. With the widespread use of power electronics equipment and nonlinear loads in industrial, residential and commercial office buildings, the modelling of harmonic sources has become an essential part of harmonic analysis [13]. This paper focuses on analysing harmonics on HPS lamps.

Apart from that, harmonic attenuation refers to the interaction of the load voltage and current distortion [14]. Various research works have shown that a nonlinear load supplied with distorted voltage will inject less harmonic

currents than those generated when the load is supplied by undistorted voltage.

Individually, single-phase power electronic-based loads pose no problem to power systems. In total, however, they have the potential to raise harmonic voltages and currents to unacceptably high levels. The two guidelines for modeling the net harmonics currents produced by these loads contemplate [15]: 1. attenuation due to system impedance and the corresponding voltage distortion that tend to reduce the net harmonic currents produced by these loads; and 2. harmonic current cancellation due to phase angle diversity.

It is evaluated the first one as second part of the paper. Upgrading to lighting equipment with clean PQ (high power factor and low harmonic distortion) can improve the power quality of the electrical system. Furthermore, upgrading with higher efficiency and higher power factor lighting equipment can also free up valuable electrical capacity. This benefit alone may justify the cost of a lighting upgrade.

Experiment with electromagnetic ballasts

The conventional electromagnetic ballast is equipment commonly used in old fashioned street lighting and it consists of a magnetic choke, a starter, and a power factor correction capacitor. The structure of the ballast system is simple, robust, and reliable. However, the "conventional" magnetic ballast has its own shortcomings, i.e., poor power regulation ability and high power loss caused by the iron and copper losses in the magnetic choke.

The advantages and disadvantages of electromagnetic ballasts can be summarized as follows [16].

Advantages:

- 1) low cost;
- 2) long lifetime (> 30 years at 105°C);
- 3) suitable for extreme weather conditions such as high humidity, wide temperature variation, and lightning;
- 4) environmentally friendly (magnetic chokes are recyclable);
- 5) self-recovery feature (when the ac mains voltage recovers after a disturbance);
- 6) very low maintenance costs;
- 7) proven record of over 50 years.

Disadvantages:

- 1) not dimmable (in the past);
- 2) not energy saving (in the past);
- 3) flickering effect;
- 8) acoustic resonance phenomenon.

Once the main characteristics of this equipment have been highlighted, in order to evaluate PQ, an experiment was done with 250 W sodium lamps and electromagnetic ballasts which cannot support dimming. From 1 to 3 lamps were connected, and many parameters were logged which perfectly show the behavior of such technology. All the lamps are connected to a three phase grid and there are one, two and three lamps connected to each phase.

The test time period was the same in all cases and environmental and electrical conditions were the actual situations expected. The lamps were connected gradually.

The monitoring device selected was a portable, stand-alone, 3-phase power quality analyzer [17]. Some of the key monitors requirements included the ability to transfer the surveyed data to an in-house computer program, appropriate numerical storage, and inexpensive and easy to use.

While the typical 3rd current harmonic value in CFLs is near 70% of the fundamental, in this case, not surprisingly, is near 18% of the fundamental. As you can see from Fig. 2, there is not a clearly decreasing tendency the higher the

harmonic orders. This tendency seems to be from 7th onwards.

There is not a clearly pattern the more lamps are connected. In the case of the 3rd and 5th harmonic orders, which have a higher impact on power quality, we cannot see a particular tendency. The bigger difference between one and three lamps connected is 2%, but between one and two connected the difference is bigger, 5% in the case of 3rd harmonic order.

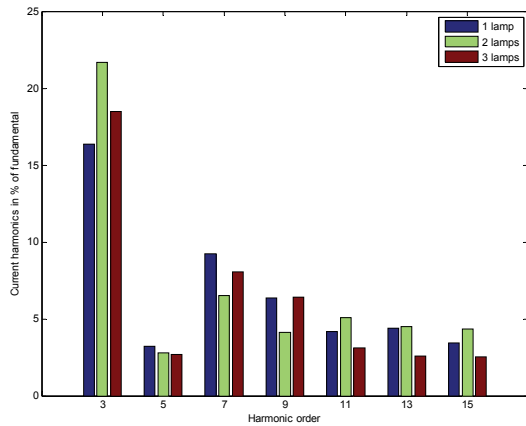

Fig. 2. Evolution in current harmonics in % of fundamental for different number of lamps connected using electromagnetic ballast.

However, as you can see from Fig. 3, in the case of voltage harmonics there is a tendency the higher the harmonic order. And most of the time, the voltage harmonic value is higher the more lamps are connected. It is important to notice that the maximum is near 0.8% in the case of 3rd harmonic.

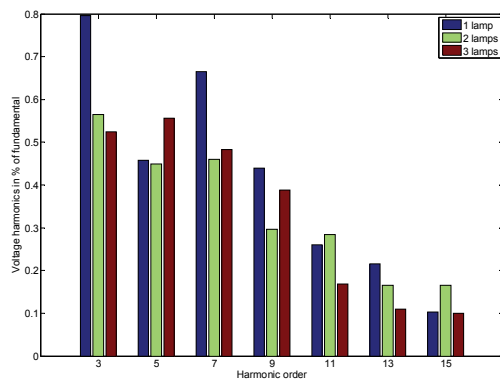

Fig. 3. Evolution in voltage harmonics in % of fundamental for different number of lamps connected using electromagnetic ballast.

So, by analyzing both figures it can be concluded that it is difficult to obtain a clearly tendency of the attenuation effect.

Experiment with electronic ballasts

Electronic ballasts have been promoted as replacements for electromagnetic ballasts for the last decade. It is usually thought that electronic ballasts are more energy efficient (typically claimed to be 10%–15%) than electromagnetic ballasts.

Further on these characteristics, the use of electronic ballasts permits to deliver a constant power to the lamp during its entire useful life, unlike electromagnetic ballasts where the output power is dependent on lamp impedance variations.

The advantages and disadvantages of electronic ballasts can be summarized as follows.

Advantages:

- 1) dimmable;
- 2) energy saving (up to 13%);
- 3) increased life lamp (30%);
- 4) no flickering effect;
- 5) high efficiency;
- 6) low audible noise;
- 7) small size.

Disadvantages:

- 1) relatively expensive;
- 2) short lifetime (typically one to five years);
- 3) relatively poor immunity against extreme weather conditions such as high humidity, wide temperature variation, and lightning;
- 4) not environmentally friendly (toxic and/or nonbiodegradable electronic waste that is not recyclable);
- 5) no self-recovery feature;
- 6) high maintenance and repair costs.

If we focus on dimmable electronic ballast, we have the main following features:

- 1) energy saving (up to 50%);
- 2) highly robust and reliable;
- 3) allowance of a wider dimming range;
- 4) wired or wireless central dimming control compatible with the electronic ballasts is needed for uniform dimming control;
- 5) over-voltage of HID lamps due to poor regulation of ac mains can be avoided.

In order to evaluate PQ in this up to date street lighting, it has been done an experiment with lamps and electronic ballasts. As seen in Fig. 1, in this experiment the behaviour of three sodium lamps has been logged. The test time period was the same in all cases and environmental and electrical conditions were the actual situations expected. From one up to three lamps were connected to the outlet, each one with different power to achieve in this way a complete range of power from 80 to 700 W. These smart ballasts can be electronically controlled at different dimming level with a voltage control signal from 1V to 10 V.

Electronic circuitry is more energy efficient than conventional ballasts. Usually the required power by each electronic ballast is around 1 W. For high frequency control, the lamps cannot be fully dimmed to extinction, and residual light output and power consumption will appear. However, such system operation may be less noticeable and less annoying to occupants. It was reported that most dimming ballasts could dim lamps to less than 20% of maximum light output.

The following figure shows the voltage and current waveform of one of this lamps.

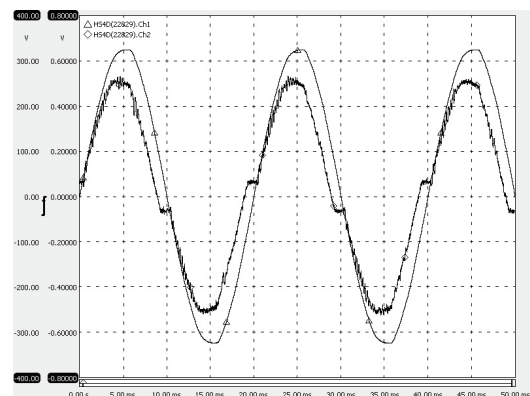

Fig. 4. Electronic ballast. Voltage and current waveform.

The monitoring device selected was a portable, stand-alone, 3-phase power quality analyzer [17]. Some of the key monitors requirements included the ability to transfer the surveyed data to an in-house computer program, appropriate numerical storage, and inexpensive and easy to use. The logged data were sent to a computer through Profibus.

As it can be seen in Fig. 1 and Table I, the experiment involved up to three HPS lamps (Philips Lighting) connected to their correspondent electronic ballast [18], [19], [20], and outdoor lamp controller [21]. The age of these lamps is the same that the lamps used in the experiment with electromagnetic ballasts. It has been chosen those power of the lamps because it is necessary to compare what happen when it is mixed different levels of power.

Table I. Lamps used in the experiments

	LAMP	BALLAST	CONTROLLER
A	Master SON 150 W	SELC 2000 HID 150 W	Candelon Node C100
B	Master SON 150 W	SELC 2000 HID 150 W	Candelon Node C100
C	Master SON 250 W	RomLight Electronic Ballast 250 W	

Three different tests were done:

- 1) Only the case A indicated in Table I.
- 2) The cases A and B
- 3) The cases A, B and C.

Each of the tests was done setting the electronic ballast to three different levels: 50%, 75% and 100%, which means that there are three different lamp power outputs.

Firstly, it has been represented for each test, the evolution of the current harmonics depending on the dimming. It can be seen in Fig. 5 that increasing the load will result in decreasing the harmonic current distortion. Additionally, the difference between at half and full load is higher for low-order harmonic currents (3rd, 5th and 7th) than for higher harmonic orders (9th, 11th and 13th). It is noticeable that the tests accomplish the limit value according to IEC 61000-3-2 [22] Class C for all the harmonic orders (PF=0.99).

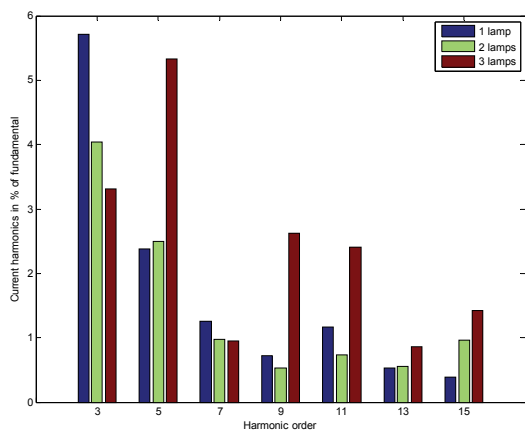

Fig. 5. Evolution in current harmonics in % of fundamental for different number of lamps connected using electronic ballast.

As in [7], Fig. 5 illustrates that the higher harmonic orders the lower their equivalent power; but this trend changes from 11th harmonic onwards. Nevertheless this doesn't happen neither in [7] nor in [6], because the fluorescent lamps decrease linearly from 3rd harmonic onwards. While the typical 3rd harmonic value in CFLs is near 70% of the fundamental, in this case, not surprisingly, is near 7% of the fundamental in test 1 at full load.

Furthermore, test 1 results in a current total harmonic distortion (THDI) of 7% at full load, that it is close from results obtained in [9], which obtained a THDI from 5.1 to 6.5% with HPS lamps connected to electronic control gear. In contrast, [6] obtained a THDI from 92.3 to 143.69% in the case of CFLs. Accordingly with [23], our loads would be of type 2: medium THDI (60-100%), dominated by harmonic currents of 3, 5, 7 and 9th order, but results show a lower THDI. These results are not surprising if it bears in mind that the ballast is a high power factor electronic ballast, and the manufacturer certifies a total harmonic distortion less than 7%.

With respect to voltage harmonic we can see from Fig. 6 that all of the values are above 0.6% of fundamental, except the 5th harmonic which rises up to over 2%.

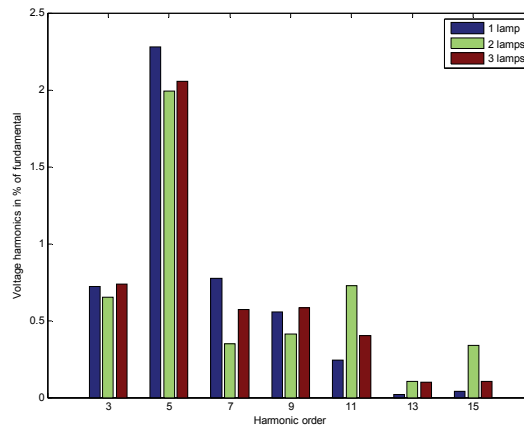

Fig. 6. Evolution in voltage harmonics in % of fundamental for different number of lamps connected using electronic ballast.

Comparison of both experiments

In order to evaluate what is happening with current harmonic depending on the technology of the used lamps, in the following figures you can see the differences between electromagnetic and electronic ballasts, the last one set to 50%, 75% and 100%. Firstly, the case with one connected lamp has been studied. As you can see from Fig. 7, the difference between the electronic ballast with power set to 100% and the electromagnetic ballast is more than double (65%). Even when the quantity of harmonic distortion is higher in the case of electronic ballast, such as at 50% of the load, the difference is double (46%).

This pattern is almost the same for all the harmonic order except for 5th order, which is between 75% and 100% of the electronic ballast.

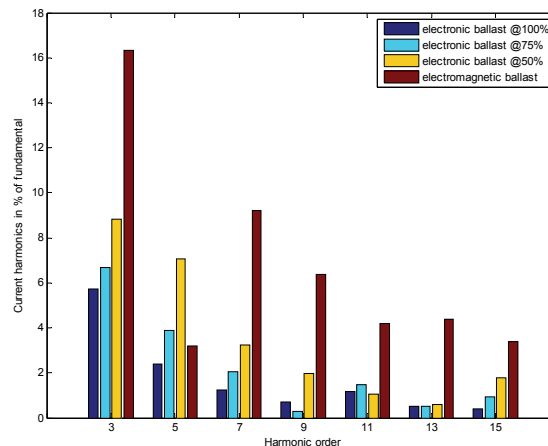

Fig. 7. Current harmonics with electronic and electromagnetic ballasts. One connected lamp.

However, when there are two connected lamps, the difference between electromagnetic and electronic ballasts is higher than when there is only one connected lamp. In the case of the 3rd harmonic order, this value in the electromagnetic is 81% higher than in the case of electronic ballast. With respect to 5th harmonic order, it happens the same that when there is only one connected, this harmonic order is the only one which doesn't fit into this pattern.

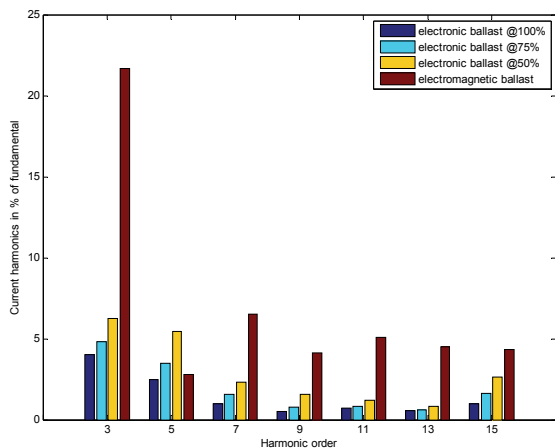

Fig. 8. Current harmonics with electronic and electromagnetic ballasts. Two connected lamps.

Finally, when there are three connected lamps, the difference between electromagnetic and electronic ballast is 82%. The same as the two previous connections, the 5th harmonic in electromagnetic is below electronic one; and also with three connected lamps the 11th and 15th are below at least one of the electronic harmonic value.

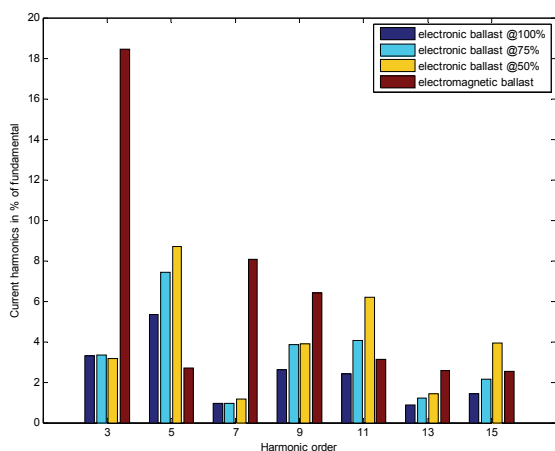

Fig. 9. Current harmonics with electronic and electromagnetic ballasts. Three connected lamps.

So it is important to point that the higher the number of connected lamps, the higher the difference between the 3rd harmonic value.

In the following two figures it has been represented both the total voltage and current distortion depending on the number of lamps. The electronic ballasts are set without dimming, so with its power established at 100%. The electromagnetic has higher voltage distortion than the electronic one. More concretely, the difference is 50% between both values.

However, in the case of the total current distortion happens the opposite, the distortion is higher in the case of electromagnetic than in electronic.

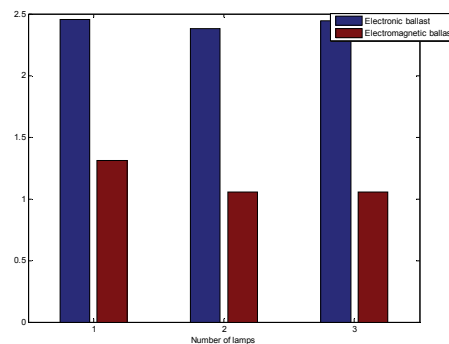

Fig. 10. THD voltage in electromagnetic and electronic ballasts versus number of lamps.

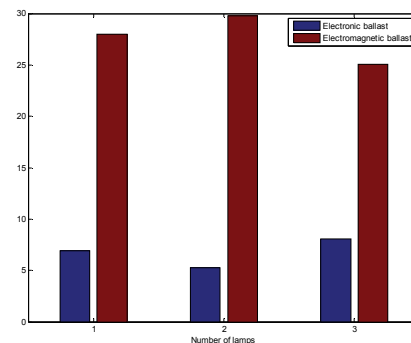

Fig. 11. THD current in electromagnetic and electronic ballasts versus number of lamps.

Attenuation effect

Nonlinear loads produce harmonic distortion according to their individual harmonic current spectrum. Traditionally, large single-point harmonics-producing loads have been treated as fixed harmonic current injectors. The same method has been used to predict the harmonic levels in distribution systems caused by large numbers of distributed single-phase loads, where the typical harmonic current spectrum of one load is scaled in proportion to total load power [15]. However, a large number of a variety of linear and non linear loads connected at the low/medium voltage bus of a distribution transformer, commonly known as the point of common coupling (PCC), really form an aggregate load [23]. Net harmonic current produced by aggregate harmonic loads (AHL) is usually significantly smaller than the algebraic sum of the harmonic currents produced by the individual nonlinear load, mainly due to phase cancellation [23]. Therefore, THDI of the aggregate load (i.e., THDI at the PCC) is influenced by both the participation (fraction) of linear loads into the total demand of the aggregate load as well as composite harmonic current spectra of the AHL.

Field measurements have indicated that THDI at the PCC of low-voltage buses typically do not exceed 20% in comparison to THDI of an individual nonlinear load, which ranges between 20%–120%. In this case, a significant reduction in THDI at the PCC can be attributed to the large fraction of linear loads in the power demand of aggregate load and harmonic current cancellation due to phase-angle diversity. This phenomenon is known as attenuation, which refers to the interaction of the voltage and current distortion and it can be as significant as 50% or greater. The assumption of attenuation will usually be valid within customer-owned facilities and should be taken into account when predicting net harmonic levels [15].

Another important characteristic of harmonic currents produced by aggregate harmonic loads is that they are

random with a changing average over time. Here it is in the presence of the cancellation related with the same kind of lamps (HPS), although with different power, but dimming with the same levels. In order to represent the attenuation effect of multiple identical loads, it is used in [14] the traditional index given as follows:

$$(1) \quad AF_h = I_h^N / (N \times I_h^1)$$

where AF_h is the attenuation factor, I_h^N is the resultant current for harmonic h for N units operating in parallel and I_h^1 is the current for harmonic h when $N=1$.

This formula indicates that, in general, the attenuation due to a shared system impedance is more pronounced for higher-order harmonics, and tends to increase with the number of lamps connected. Although the attenuation factor increases in 13th and 15th harmonics, it is not important since current magnitudes will be negligible in those orders.

By the contrary, [5] and [24] stated that the previous equation doesn't fit in the case of CFL; consequently, they propose the below index, which is obtained by employing 12 CFLs connected to different wire lengths.

$$(2) \quad Neq_h = I_h^N / I_{h_0}^1$$

where Neq_h is the equivalent lamp index, I_h^N is the measured total h th harmonic current for parallel N CFLs and $I_{h_0}^1$ is the h th current harmonic produced by one CFL under undistorted voltage supply conditions.

After using both formulas and in the case of sodium lamps, neither the first nor the second is consistent with our data. Because of that, it decided to propose another equation that, based on field experiment could justify the results obtained. It is inspired on the IEC 61000-3-2 [22], where, for devices belonging to D class, the maximum permissible harmonic current is rated with power, and harmonic value depends on the power of the system. It has mixed up the effects produced by dimming lamps in a wide range with the fact that there are three combinations of lamps with different power. Thus, the equivalent lamp index proposed here is the following:

$$(3) \quad Neq_h = I_h^{P_i} / (P_i * I_{h_0}^1)$$

where Neq is the number of equivalent lamps, $I_h^{P_i}$ is the h th total current harmonic measured for P_i power of three lamps and $I_{h_0}^1$ is the h th current harmonic produced by less power. This index is essentially the ratio of the h th harmonic current produced by P power to the h th harmonic current produced with less power considered weighted with the power in this moment.

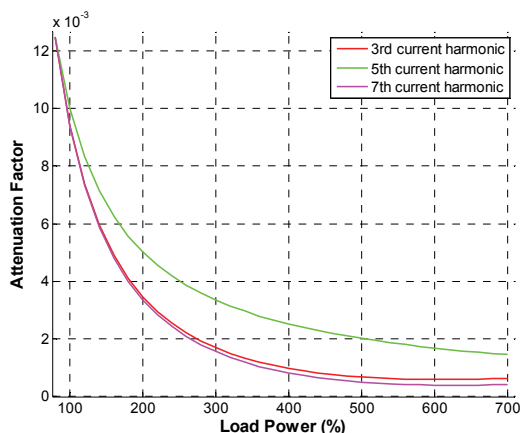

Fig. 12. Attenuation effect of the HPS lamps for 3rd, 5th, and 7th harmonics.

This results in a family of Neq_h curves, each representing the attenuation effect at a particular harmonic number. The three sample curves shown in Fig. 12 reveal the consistency of our approximation.

In addition, this figure indicates that a reduction of the harmonic current occurs when the supply voltage becomes more distorted. Harmonic 3rd has higher value than the rest; the higher the power the lower the harmonic value for all the orders; and at the highest power of the load, all of the harmonic values tend to the same one.

Conclusion

In this paper it has presented a harmonic analysis on two tests that implied three HPS lamps, electromagnetic and electronic ballasts with controllers to dim the light. It has compared this analysis with others made by different authors over CFLs. The results obtained are partially similar, i.e., the decrease in the harmonic value as increase the harmonic order, and also the decrease in the value at half load. But the pattern isn't the same because it changes with higher order harmonic.

This study also found that THDI is lower with HPS lamps than with CFLs, and THDI. The harmonic current distortion in a single type load is highly dependent on the loading level because is higher at half load than at full load.

Although the technical features of a lighting installation are the first determinant of power efficiency, the ultimate determinant is effective operation management. The operation of lighting installations presents unique features that, besides geographical dispersion, make the right management difficult.

This research was supported by the Company Telvent Energy, Spain, through the project Malaga SmartCity under contract number 12009028. SmartCity's budget is partly financed by the European regional development fund (ERDF) with backing from the Junta de Andalucía and the Ministry of Science and Innovation's Centre for the Development of Industrial Technology. The authors would like to thank the Spanish Ministry of Industry, Tourism and Trade for funding the Project TSI-020100-2010-484 which partially supports this work. Our unforgettable thanks to the Spanish Ministry of Science and Innovation for funding the research project TEC2010-19242-C03-02.

REFERENCES

- [1] Electricity for More Efficiency: Electric Technologies and their Energy Savings Potential. Union of the Electricity Industry-EURELECTRIC. July 2004
- [2] Energy Efficient Streetlights -- Potentials for Reducing Greater Washington's Carbon Footprint --. Prepared by: Robert T. Grow, ACCE Ford Fellow (Greater Washington Board of Trade). March 18, 2008
- [3] Ali, N.A.M., Fadzil, S.F.S., Mallya, B.L. Improved illumination levels and energy savings by uplamping technology for office buildings. 2009 *International Association of Computer Science and Information Technology - Spring Conference, IACSIT-SC 2009*, art. no. 5169423, pp. 598-603.
- [4] Ceclan, A., Micu, D.D., Simion, E., and Donca, R. Public lighting systems - an energy saving technique and product.
- [5] Nassif, A.B., Xu, W. Characterizing the harmonic attenuation effect of compact fluorescent lamps. 2009. *IEEE Transactions on power delivery*, 24 (3), pp. 1748-1749.
- [6] Nassif, A.B., Acharya, J. An investigation on the harmonic attenuation effect of modern compact fluorescent lamps, 2008, *ICHQP 2008: 13th International Conference on Harmonics and Quality of Power*, art. no. 4668759
- [7] El-Saadany, E.F., Salama, M.M.A. Effect of interactions between voltage and current harmonics on the net harmonic current produced by single phase non-linear loads. 1997 *Electric Power Systems Research* 40 (3), pp. 155-160

- [8] Suárez, J.A., Di Mauro, G.F., Anaut, D.O., Agüero, C.A. Partial cancellation of harmonic currents caused by nonlinear residential loads. 2005 *Informacion Tecnologica* 16 (3), pp. 63-70.
- [9] Manzano, E.R., Carlorosi, M., Tapia Garzón, M. Performance and measurement of power quality due to harmonics from street lighting networks. 2009 *International Conference on Renewable Energies and Power Quality (ICREPQ'09)*. ISBN: 978 84 612 8010 8
- [10] Power quality guidelines for energy-efficient device application. Consultant report. Prepared By: Electric Power Research Institute. January 2003.
- [11] Moreno-Muñoz, A. Power quality. Mitigation Technologies in a distributed environment. 1st edition. London. Springer. 2007.
- [12] Salmerón, P., Herrera, R.S., Valles, A.P., Prieto, J. New distortion and unbalance indices based on power quality analyzer measurements. 2009 *IEEE Transactions on Power Delivery* 24 (2), pp. 501-507.
- [13] Acarkan, B., Erkan, K. Harmonics modeling and harmonic activity analysis of equipments with switch mode power supply using MATLAB and simulink. 2007 *Proceedings of IEEE International Electric Machines and Drives Conference, IEMDC 2007* 1, art. no. 4270692, pp. 508-513.
- [14] Mansoor, A., Grady, W.M., Chowdhury, A.H., Samotyj, M.J. An investigation of harmonic attenuation and diversity among distributed single-phase power electronic loads. 1995. *IEEE Transaction Power Delivery*, 10 (1), pp. 467-473.
- [15] Grady, W.M., Mansoor, A., Fuchs, E.F., Verde, P., Doyle, M. Estimating the net harmonic currents produced by selected distributed single-phase loads: Computers, televisions, and incandescent light dimmers. 2002 *Proceedings of the IEEE Power Engineering Society Transmission and Distribution Conference 2*, pp. 1090-1094.
- [16] Chung, H.S.-H., Ho, N.-M., Yan, W., Tam, P.W., Hui, S.Y. Comparison of dimmable electromagnetic and electronic ballast systems-an assessment on energy efficiency and lifetime. *IEEE Trans. on Industrial Electronics* 54 (6), pp. 3145-3154.
- [17] PM130EH Plus, SATEC is the Company. Available at: <http://www.satec-global.com/eng/products.aspx?product=44>
- [18] SELC 2000 HID Smart Ballast 150 W. Available at: <http://www.selc.ie/media/pdf/SELC2000-1.pdf>
- [19] ROMlight International Inc. HID Electronic Ballast. Available at: <http://www.romlightintl.com/ballasts.cfm>
- [20] SELC 2000 HID Smart Ballast 70 W. Available at: <http://www.selc.ie/media/pdf/SELC2000-2.pdf>
- [21] SELC CANDELON NODE C100 – Outdoor Lamp Controller. Available at: <http://www.selc.ie/media/pdf/C100-10.pdf>
- [22] IEC 61000-3-2 Standards on Electromagnetic Compatibility (EMC), Part 3, Section 2: Limits for Harmonic Current Emissions, 2005.
- [23] Au, M.T., Milanović, J.V. Development of stochastic aggregate harmonic load model based on field measurements. 2007 *IEEE Trans. on Power Delivery* 22 (1), pp. 323-330.
- [24] Yong, J., Chen, L., Nassif, A.B., Xu, W. A frequency-domain harmonic model for compact fluorescent lamps. 2010 *IEEE Transactions on Power Delivery* 25 (2), art. no. 5332254, pp. 1182-1189

Authors: PhD Aurora Gil de Castro, prof. Dr. Antonio Moreno Muñoz, Research Group PAIDI-TIC-168: Computational Instrumentation and Industrial Electronics (ICEI), Andalusia, Spain. University of Córdoba, Area of Electronics, Campus de Rabanales, Leonardo da Vinci building. E-14071 Córdoba, Spain, E-mail: agil@uco.es