

Study of 6 electrodes gliding arc discharge configuration

Abstract. Experimental results of the I-V characteristics of the 6 electrode gliding arc discharge are presented. As a power system two 3-phase transformers were used instead of sixth-phase transformer. Power and energy in the two-, three- and six electrodes reactor were measured and photographs of the discharge development by high speed camera were detected.

Streszczenie. Przedstawiono badania charakterystyk prądowo-napięciowych ślizgającego się wyładowania łukowego w konfiguracji 6 elektrodowej. Jako układ zasilania wykorzystano dwa transformatory trójfazowe. Mierzono moc i energię wyładowania w układzie dwu-, trzy- i sześcioelektrodowym oraz rejestrowano rozwój wyładowania za pomocą szybkiej kamery. (Badania ślizgającego się wyładowania łukowego w konfiguracji 6-elektrodowej).

Keywords : gliding arc, non-thermal plasma, 6 electrodes AC discharge

Słowa kluczowe: ślizgający się łuk elektryczny, plazma nietermiczna, 6. elektrodowe wyładowanie zmiennoprądowe

Introduction

At present, processing of exhaust hazardous gases is a top priority for environmental protection engineering. Plasma techniques has been used for purification of the exhaust gases pollution. Among them Inductively Coupled Plasma (ICP) is suitable technique for a decomposition of polluted gases, and therefore, it is used widely. Gas pollutants and organic matter are almost completely decomposed in the high temperatures (5000-20000)K of inductively coupled plasma and equipment is quite simple, but large amount of electric power is required to maintain the plasma at atmospheric pressure and near to thermal equilibrium.

Study of gliding arc discharges (GAD) to gas processing has been reported recently in many papers [1-12]. GAD can generate atmospheric pressure plasma with much less input power in comparison with ICP. But, processing of large quantity of polluted gases at non-thermal and non-equilibrium conditions requires large volume of plasma, which is not easily obtainable with the gliding arc discharges. Systems that combines catalysts with GAD have been also reported [12]. Furthermore, the basic processes of this kind of plasma are not enough identified.

Studies presented in this paper were carried for the purpose to enhance plasma volume in the 3. and 6. electrode gliding arc reactor [1-2]. Simple power supply system was proposed with 6 phases alternating current.

Experiments

Experimental setup is depicted in Figure 1. Six pieces of knife edge-shaped electrodes made from pure iron were located at angle of 60 degrees to each other in the tubular geometry of the glass container. The electrode distance was adjustable from 0 to 10 mm. Figure 2 shows photography of electrodes with discharges.

Pure argon gas was introduced between electrodes at their lower part and gas flow was controlled by a flow meter. Gas flow rate was adjustable from 0 to 30 L/min. Two 3-phase line high performance power transformers of maximum voltage 6,6 kV were used in reverse connection to realize six phases power system. High voltage ignition electrode hasn't been used in the experiment to avoid unnecessary interferences that can render difficult explanation of gliding arc plasma phenomena.

Currents and voltages of each electrode were measured by digital oscilloscope with a high voltage probe (Nissin pulse elec : EP-50K) and a current probe (Hioki : 9555-10/9272-10, respectively). The discharge was observed using two cameras: conventional and high-speed.

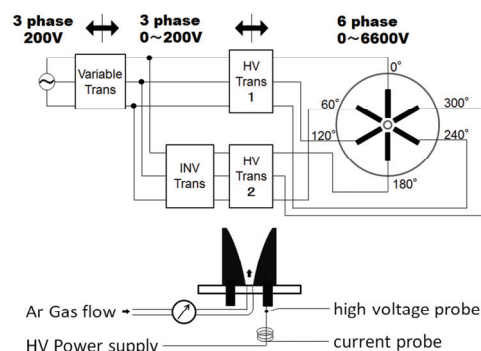

Fig.1 Experimental setup

Results

Figure 2 shows picture of GA reactor electrodes with discharges and Figure 3 depicts a voltage waveforms before and during discharges in the 3 electrode reactor.

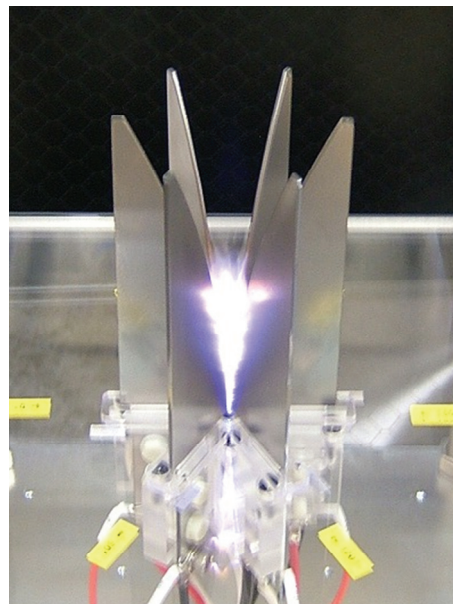

Fig.2 Picture of 6 electrodes gliding arc system

Absence of the ignition electrode caused that up to 3300 V discharges didn't start-up, but after the ignition, discharges were maintained at voltage value equal to 2000 V or even less. Gas flow rate was 10 L/min. Before discharges the phase shift between each voltage phase

was 120 degree. During discharges the voltage waveform was similar to observed in two-electrode (single phase) or six-electrode gliding arc discharge. With supply voltage increasing from 3kV to 6 KV, length of discharge increased as well.

Figure 4 shows picture of GA discharge with argon as a processing gas, which flow rate was negligible (0 L/min). The purpose of this experiment was to confirm the proper setting of the electrodes and correct operating of six-phase power supply system. As it is seen from Figure 4, in the between-electrodes central position, discharges create the most low-impedance midpoint and there are not discharges between adjacent electrodes.

Figure 5 shows photography and *I-V* characteristics aside. Applied voltage was 4 kV and electrodes' shortest distance was 4 mm. With enlargement of the argon amount introduced to the discharge gap from 0 L/min to 20 L/min the discharge length growth.

Figure 5(a) shows that the discharge takes place every 3,33 seconds at the gas flow rate equal to 0 L/min, as the frequency of power supply system was 50Hz. An increase of gas flow rate causes increasing frequency of discharges in the period of supply voltage (Fig.5 (b), (c)).

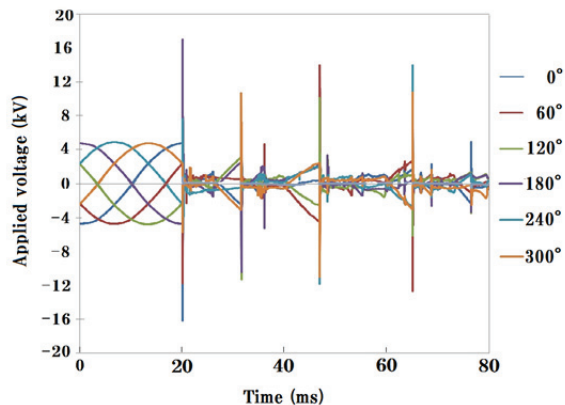

Fig.3 Voltage characteristic of gliding arc discharge



Fig.4 Photo of gliding arc discharge from top view.

We have also measured the *I-V* characteristics in the two, three and six electrodes' GAD reactors. Power was calculated by multiplying the voltage and current and after integrating the product energy was calculated.

Figure 6 shows power (watt) and electric energy (joule) chart of single phase, 3 phase, and 6 phase power supply system of 2, 3 and 6 electrodes GAD reactor.

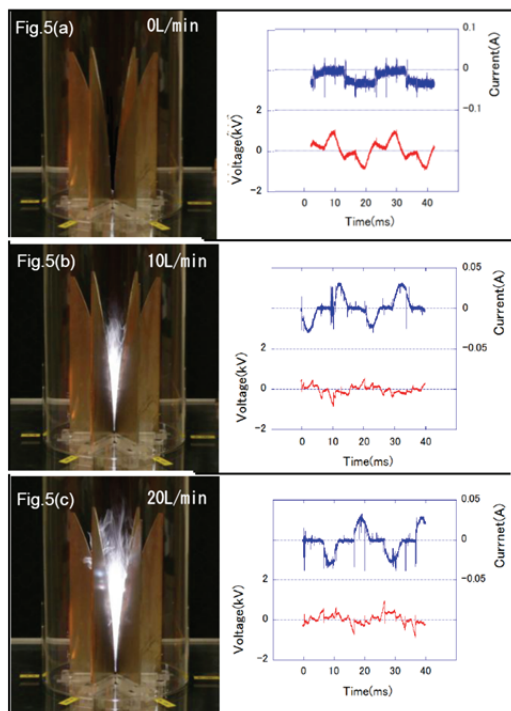

Fig.5 Photograph and I-V characteristic

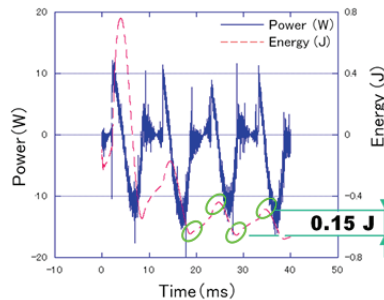

Fig. 6a Power and energy courses in two-electrode gliding arc discharge

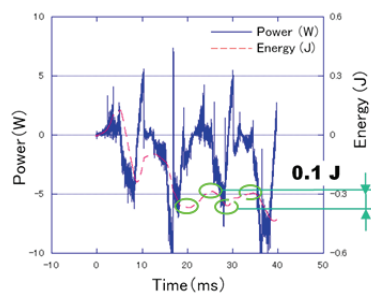

Fig. 6b Power and energy courses in 3 electrode gliding arc discharge

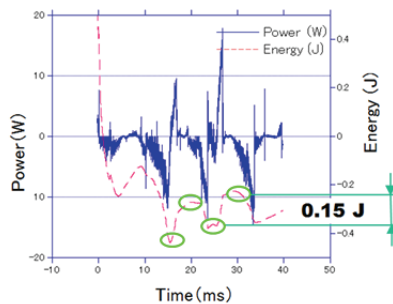

Fig.6c Power and energy courses in 6 electrode gliding arc discharge

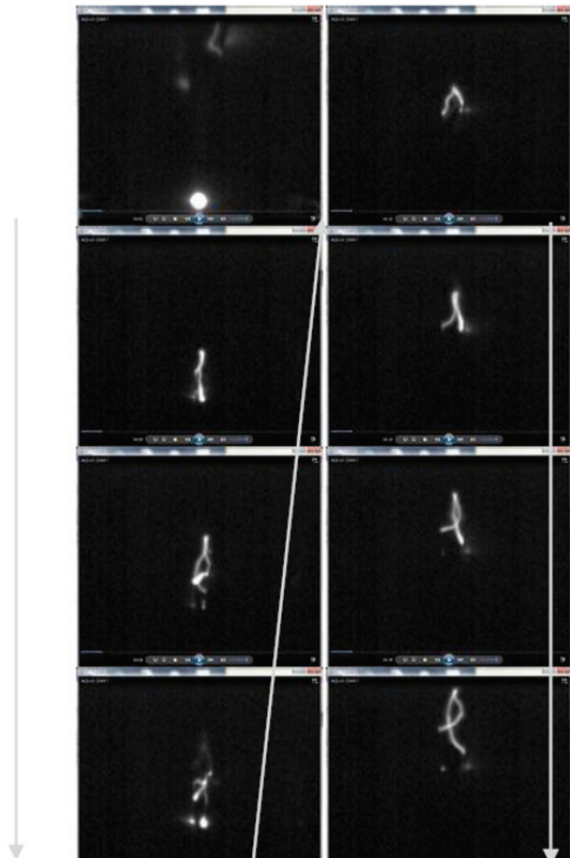

Fig.7 Photograph of gliding arc discharge by high-speed camera

Results indicate that the number of electrodes influences the power and energy courses in small extent. From Figures 6a, b and c the energy can be calculated as below:

2 electrodes	$0,15\text{J} \times 1 = 0,15\text{ J}$
3 electrodes	$0,10\text{J} \times 3 = 0,30\text{ J}$
6 electrodes	$0,15\text{J} \times 6 = 0,60\text{ J}$,

what means that larger number of electrodes causes more energy directed to the discharge zone.

Figure 7 shows the sub-msec order discharges observed with a high-speed camera. Frame rate was 10000. Applied voltage was 5 kV and electrode shortest distance was 6 mm. Argon flow rate was 20 L/min.

After ignition, more than one arc discharges were observed. Average velocity of discharges, calculated on the base of the frame rate was 33,5 m/s.

Conclusion

General-purpose equipment for 6 electrode gliding arc discharge energized from 6 phase power supply was studied in the paper from the point of view of its *I-V* as well as power and energy courses.

It was confirmed that larger number of electrodes causes more energy directed to the discharge zone and that discharges can be generated in bigger volume of GAD reactor.

REFERENCES

- [1] Stryczewska. H. D. and Komarzyniec. G. K., Properties of gliding arc (GA) reactors energized from AC/DC/AC power converters, Proceedings of 2010 IEEE Region 8 International Conference on Computational Technologies in Electrical and Electronics Engineering, SIBIRCON-2010, 744-749
- [2] Komarzyniec. G., Diatczyk. J. and Stryczewska. H. D., Arc plasma reactor power system with 5-limb transformer, Journal of Advanced Oxidation Technologies, Vol. 9 (2006), 178-181
- [3] Stryczewska, H.D., Diatczyk, J., Pawlat, J., Temperature distribution in the gliding arc discharge chamber, Journal of Advanced Oxidation Technologies, Vol. 14 (2) (2011) pp. 276-281
- [4] Pawlat, J., Diatczyk, J., Stryczewska, H.D., Low-temperature plasma for exhaust gas purification from paint shop - A case study, Przegląd Elektrotechniczny, Vol. 87 (1) (2011) pp. 245-248.
- [5] M. Mlotek, J. Sentek, K. Krawczyk and K. Schmidt -Szalowski, The hybrid plasma-catalytic process for non-oxidative methane coupling to ethylene and ethane, Applied Catalysis A: General, 366 (2009), 232-241.
- [6] K. Krawczyk, B. Ulejczyk, H. K. Song, A. Lamenta, B. Paluch and K. Schmidt-Szalowski, Plasma-catalytic reactor for decomposition of chlorinated hydrocarbons, Plasma Chemistry and Plasma Processing, 29 (2009), 27-41.
- [7] A. Fridman, S. Nester, L. A. Kennedy, A. Saveliev and O. Mutaf-Yardimci, Gliding arc discharge, Progress in Energy and Combustion Science, 25 (1999), 211-231.
- [8] L. Yu, X. Li, X. Tu, Y. Wang, S. Lu and J. Yan, Decomposition of Naphthalene by dc Gliding Arc Gas Discharge, Journal of Physical Chemistry A 114 (2010), 360-368.
- [9] Z. Bo, J. Yan, X. Li, Y. Chi and K. Cen, Plasma assisted dry methane reforming using gliding arc gas discharge: Effect of feed gases proportion, International Journal of Hydrogen Energy 33 (2008), 5545-5553.
- [10] T. Nakamiya, F. Mitsugi, S. Suyama, T. Ikegami, Y. Sonoda, Y. Iwasaki and R. Tsuda, Investigation of Electric Discharge Sound in Atmospheric Pressure Plasma, Journal of Advanced Oxidation Technologies 13 (1) (2010), 43-49.
- [11] R. McAdams, Prospects for non-thermal atmospheric plasmas for pollution abatement, J. Phys. D: Appl. Phys. 34, (2001) 2810
- [12] J. S. Chang, T. Myint, A. Chakrabarti, A. Miziolek, Decomposition of toluene by streamer corona discharge with catalyst, Jpn. J. Appl. Phys. 36, 5018 (1997)
- [13] K. Krawczyk, B. Ulejczyk, Influence of Water Vapor on CCl₄ and CHCl₃ Conversion in Gliding Discharge Plasma Chemistry and Plasma Processing, 24, 2, 155 (2004)

Authors: Tetsuro Baba, and Yukio Takeuchi, VIC International Inc., Nagaoka 2-1-2, Nishitama-gun Mizuho city, Tokyo 190-1232, Japan, E-mail: baba@vic-int.co.jp ; Prof. Shin-ichi Aouki, Sojo University, Ikeda 4-22-1, Kumamoto city, Kumamoto 860-0082, Japan, E-mail: aoqui@cis.sojo-u.ac.jp
 Prof. Henryka Danuta Stryczewska, Institute of Electrical and Electrotechnologies, LUT, 38A Nadbystrzycka, 20-618, Lublin, Poland, E-mail: h.stryczewska@pollub.pl