

Performance of active power filter in transient under non-linear loading

Streszczenie. W artykule przedstawiono analizę i wyniki badań efektywności kompensacji mocy biernej za pomocą aktywnego filtra mocy (APF) sterowanego wg algorytmu opracowanego na podstawie teorii składowych fizycznych prądu (CPC). Scharakteryzowano układ APF i przedstawiono uzyskane wybrane wyniki badań laboratoryjnych kompensacji mocy biernej odbiorów nieliniowych w stanach przejściowych. **Analiza i wyniki badań efektywności kompensacji mocy biernej za pomocą aktywnego filtra mocy**

Abstract. The paper analyses and examines the efficiency of operation of a newly developed active power filter (APF), based on a control algorithm using CPC theory when employed in transient under non-linear load conditions. The APF system is therefore, characterized and the selected results of its performance under laboratory testing are presented and discussed.

Słowa kluczowe: praca aktywnego filtra mocy w stanach przejściowych.

Keywords: nonlinear load, active power compensation, performance of APF operation in transient.

Introduction

In today's electric power systems the electric energy quality and its highest transmission efficiency (to the user) are very important prerequisites to meet. For sinusoidal both current and voltage waveforms the reduction of transmission losses requires a respective decrease in a load current value thus reduction (preferably to zero) of a reactive power Q so that the apparent S value was virtually equal to the active power P delivered. The power factor value $\cos \varphi$ (or recently tangent) defined under the known relationship is the indicator:

$$(1) \quad \cos \varphi = \frac{P}{S} = \frac{P}{\sqrt{P^2 + Q^2}}$$

where: P – active power (useful power), S – apparent power, Q – reactive power.

Due to the fact that most of the load is inductive therefore, the simplest way to compensate reactive power, in electric power systems with sinusoidal waveforms, is a parallel connection of a respectively selected capacitive loads in the form of a capacity banks and/or rotating overexcited synchronous motors. Unfortunately, more and more consumers of electricity use non-linear loads being fed through the appropriate frequency converters. This applies to both small power receivers such as electronic devices, modern light sources, computer equipments etc as well as high power units like asynchronous motors with frequency speed control etc. Examples of this type of load with deformed current and voltage waveforms and harmonics spectrum are shown in Fig. 1 and Fig. 2:

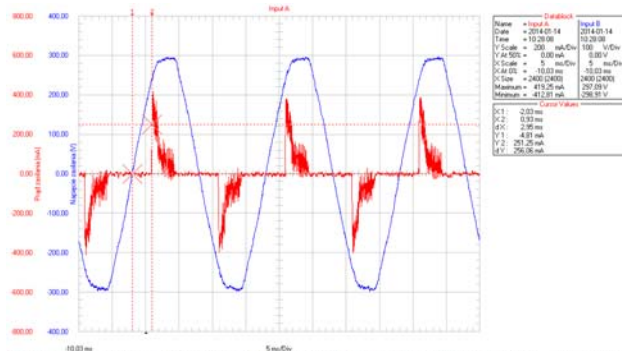

a)

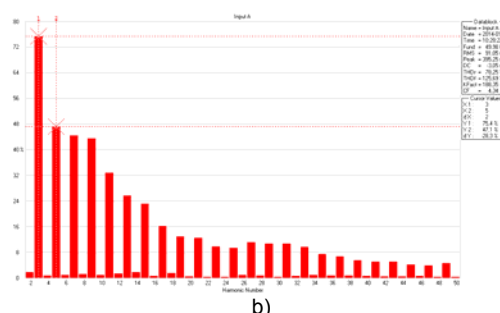

Fig. 1. Voltage and current waveforms for compact fluorescent lamp Brilux 2U 18W type (a); current harmonics spectrum (b)

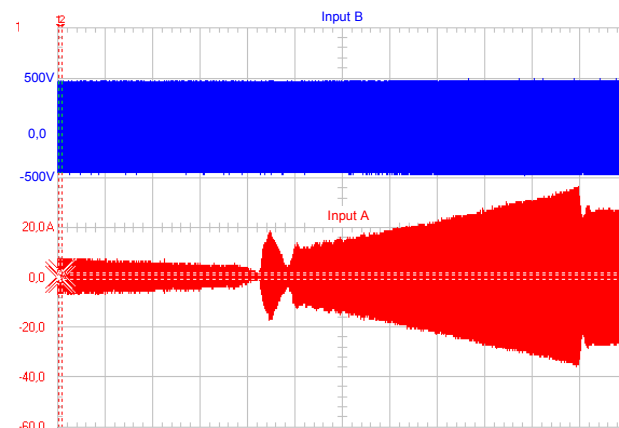

Fig. 2. Voltage and current waveforms at start-up of an asynchronous motor (63kW, 525V) by frequency inverter in the range of 0-30Hz

In such cases of non-linear loads and/or for sinusoidal currents and voltages however, supplying unbalanced 3-phase circuits one has to face fundamental theoretical problem with right definition of both active and reactive power and therefore, the problem with implementation of an effective method of a reactive power compensation. The non-linear loads draw primarily deformed currents, which for periodic waveforms can be expressed in the form of a Fourier series:

$$(2) \quad i(t) = I_o + \sum_h \sqrt{2} I_h \cdot \sin(\omega_h t + \varphi_h)$$

where: I_o – dc component, I_h – rms value of “h” harmonic, φ_h – phase shift for “h” harmonic

The result can vary under operation, even in a very short time, both if about the content of higher harmonics, their amplitudes and phase shift angles what makes difficult as interpretation of physical phenomena as their analysis. Already in 1920 it was demonstrated that power factor can be smaller than one even if the load is purely resistive. It concerned unbalanced circuits with symmetrical voltage and currents [1].

The theoretical basis of reactive power compensation in system with deformed voltage and current waveforms

The complexity of physical phenomena in electric circuits with non-sinusoidal current and voltage waveforms was the reason for the lack of adequate theory suitable for use in reactive power compensation for more than 90 years despite numerous attempts made in this regard. Neither, for example, power theory of Budeanu (1928) nor this developed by Fryze (1931) created the basis for the practical implementation of reactive power compensation in these circuits. It should be stressed that so far there is no consistent and unambiguous theory linking the mathematical description of phenomena to their logical physical interpretation. A step forward in this respect was instantaneous power theory (IPT) published in 1981 [2] although it does not allow a sufficient coherent explanation of theory energy exchange phenomena in nonlinear circuits. Another important achievement for interpretation of physical phenomena was publication of the theory of the physical current components (CPC) in 1984 [3]. This theory is based on the analysis of voltage and current signals in the frequency domain and lets you define the relevant physical components of the distorted load current as follows:

- i_a - the active component responsible for the active energy (power) transfer from source to load,
- i_r - reactive component due to the load susceptance,
- i_h - current component due to high harmonics of a non-linear load,
- i_u - unbalanced component related to voltage asymmetry (unbalance) of the source,
- i_s - scattering current component related to both high harmonics in the voltage source and variation of load impedance value Z_L with frequency (it is not involved in the transfer of energy from source to load).

Each defined component is responsible for a different energy effect in the circuit and, in a structural way, is orthogonal to the sum of rms value of respective components as illustrated in Fig. 3:

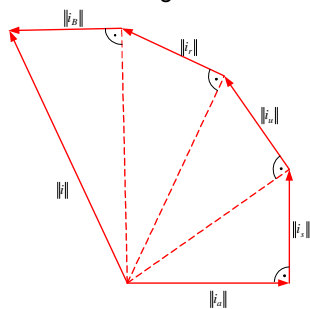

Fig. 3. Polygon of rms values of current components according to CPC theory [3]

In fact both theories (CPC) and (IPI) make it feasible to develop the effective system (to varying degrees) of

compensation in circuits with deformed voltage and current waveforms [4, 5, 6]. However, to accomplish it, not only reactive component (i_r) should be eliminated but also must be effectively reduced all other current components (i_u , i_s , i_h), what is not easy to achieve it in practice. For this purpose, it is essential to use an arrangement which is so-called active power filter (APF). It allows for generation of such additional (reference) current component i_F which injected into the circuit only allows for flow of active current component i_a (see Fig. 4):

$$(3) \quad i_F + i_L = i_S = i_a$$

where: i_L – load current, i_S – network current.

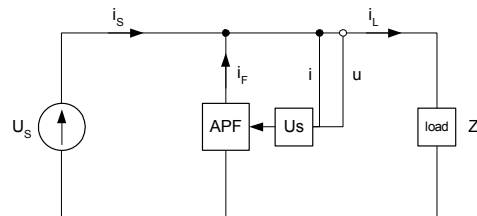

Fig. 4. Simplified scheme of circuit with active power compensation applied; Z_L – load (receiver) impedance, APF – active power filter, U_s – control unit, i_L – load current, i_F – reference (additional) current, U_s , i_s – network voltage and current respectively

Today's development of technology makes it possible to realize such an effective compensation system that connected to respective electrical circuit allows both spectral analysis of current and voltage waveforms and define as well as generate a current waveform of such a reference current component which will be able to meet the requirement (3). It should be noted that in the circuits with nonlinear loads changes in both the nature, most of all, of the current deformation and its instantaneous value can take plays very fast with time and often even randomly. Therefore, the efficiency of the active power filter is quite significantly related to its operation in transient. Every so the filter should be thoroughly tested under dynamic changes of the non-linear loads. It must be emphasized that the application of the CPC theory (adopted by the authors as the most logical) requires the calculations of complex values of all harmonics U_h and I_h found in the measured both voltage and current signals. Thus, the control algorithm based on the CPC theory requires first an analysis of voltage and load current harmonics and then make the necessary mathematical operations for calculating the particular current component and develop as a result the reference current i_F [7, 8].

Laboratory studies of the dynamics of the active compensation system

A. Testing system and measurement method

Testing of efficiency and dynamics of operation of a developed physical model of APF (nominal power equal to around 10kVA) carried out in the system as shown in Fig. 5. A block diagram of the developed active power system is illustrated in Fig. 6.

The physical model of the parallel active power filter consists of necessary units that fulfill following functions:

- control algorithm (AS-CPS),
- regulator of a reference current (UR- i_F),
- gate signals generator of power module,
- capacity voltage regulator of power module,
- power module/unit (IPM),
- capacity (C_F) feeding the power module,
- reactors L_{APP} ,
- gate signals fiber separator (from the power unit)

The active power filter cooperates with power supply in open loop system (current and voltage signals are taken from the side of a nonlinear load; just behind the connection point of the APF to the supplying network). This way of solution makes it easier to obtain stable regulation system conditions.

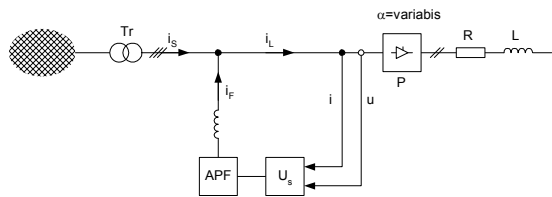

Fig. 5. Schematic for testing of the effectiveness of the active compensator under dynamic load changes, APF – active power filter, U_s – control system, R, L – load, P – controlled rectifier (α – specified angle of delayed conduction), i_s – network current, i_F – additional (reference) current, i_L – load current

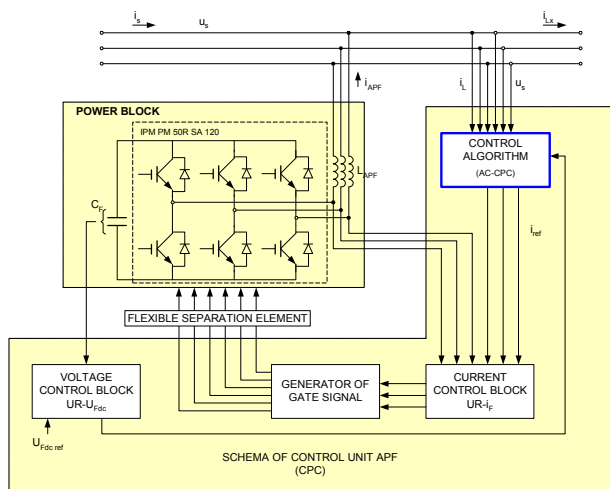

Fig. 6. A block diagram of the developed APF (10kVA)

General view of lab test stand and physical model of the developed APF are shown in Fig. 7 and Fig. 8 respectively. The study included the operation of the system for both the linear and non-linear loads under steady states as well as in transient.



Fig. 7. View of the developed active power filter (APF)

For the non-linear load, three phase thyristor rectifier was loaded with R,L type unit ($R=18.5 \Omega$, $L=18.6\text{mH}$) and the performance in transient was inspected under simulated step change of the conduction angle α in the range of 0° to 50° and reverse. It was implemented through a corresponding change in the value of the control voltage as illustrated in Fig. 9.

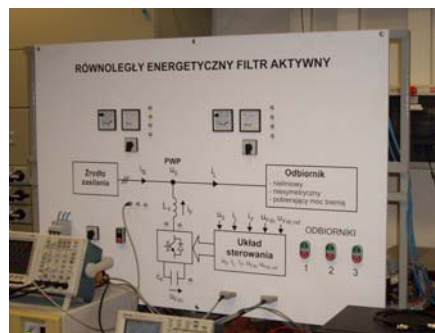

Fig. 8. Overview of laboratory test stand

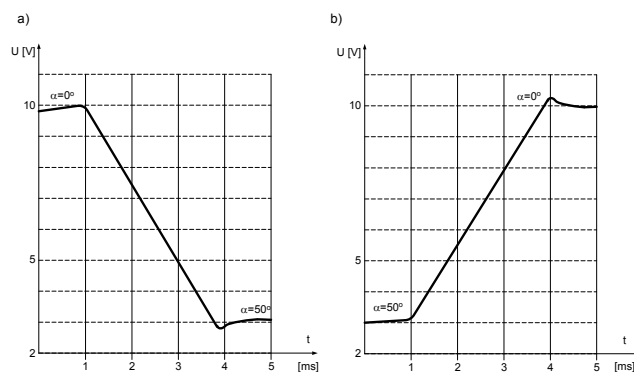
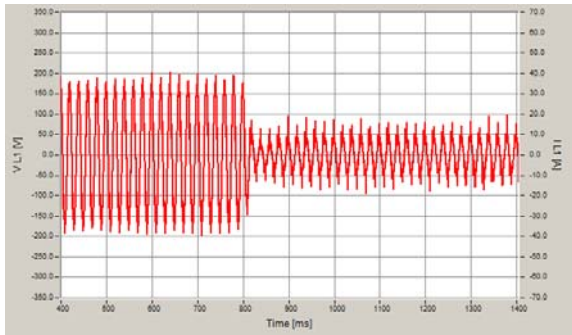

Fig. 9. Variation of a control voltage signal; a) from 0° to 50° , b) from 50° to 0°

B. Investigated results

In electric power systems due to variation in a number of parameters (voltage level, short circuit power, load, content and level of high harmonics etc) a key factor is a response of APF under transient states. This includes effective and respectively fast operation under any change in the nature of electric quantities waveform due to non-linear loads. For this purpose the appropriate tests were carried out for the developed APF system under transient modelled by a step change of the conduction angle delay time from 0° to 90° at every 10° . To evaluate the efficiency of the APF operation relevant electrical parameters were measured and recorded, above all, the values and harmonics spectrum of a current spectrum drawn by the non-linear load, the reference current waveform drawn from the source before and after application of the active compensation. Other important electrical parameters were also controlled and analyzed such as supply voltage, active and reactive power, power factor as well as high harmonics level in currents and supplying voltage waveforms. It was found that all electrical parameters analyzed were kept unchanged i.e. their values were the same as under steady state conditions for the fixed (given) angle value. Delay time of a step change in the angle during the test did not exceed 3ms (see Fig. 9). The response of the APF to simulated dynamic changes in the nature of non-linear loading stabilizes within time not exceeding 15ms, which is sufficient from a practical point of view. Selected for example, measured electrical quantities and their waveforms (network current, reference current component generated by the filter, non-linear load and network voltage) under step change of the conduction angle are presented in Fig. 10-13. They are related to a step change in the angle from 0° to 50° (Fig. 10-11) and reverse from 50° to 0° (Fig. 12-13).



a)

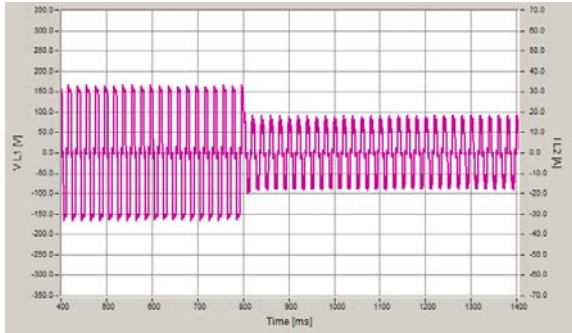

b)

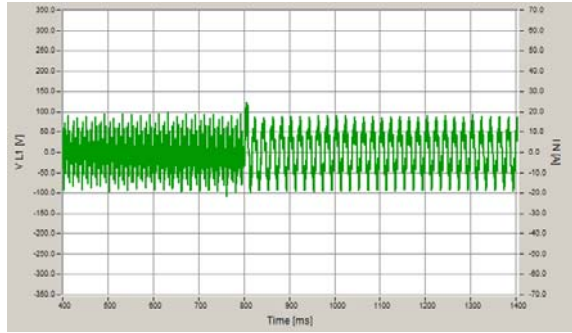

c)

Fig. 10. Variation of voltage and network current waveforms (a), non-linear load current (b) and reference current (c) under step way change of conduction angle from 0° to 50°

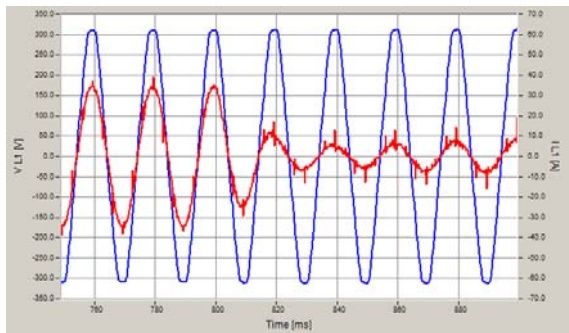

a)

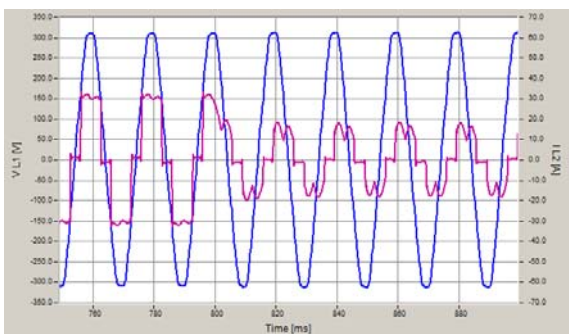

b)

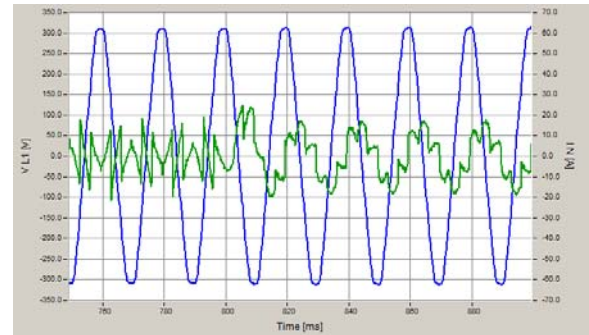

c)

Fig. 11. Extended (in time) measured quantities as in Fig. 10

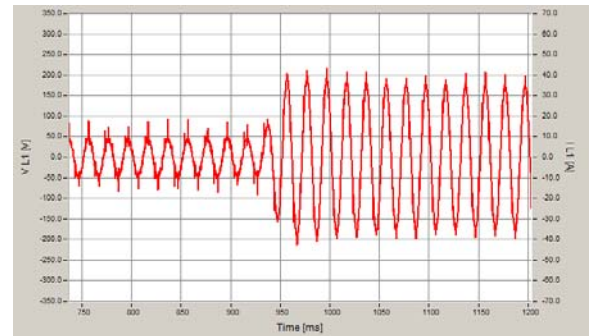

a)

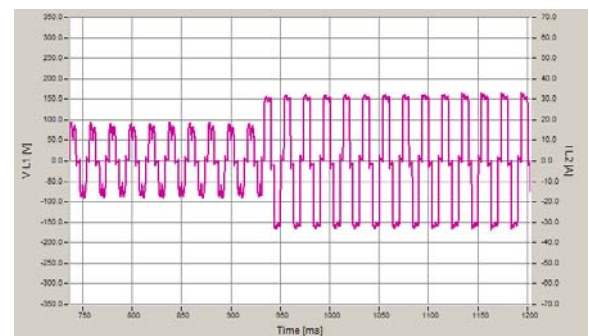

b)

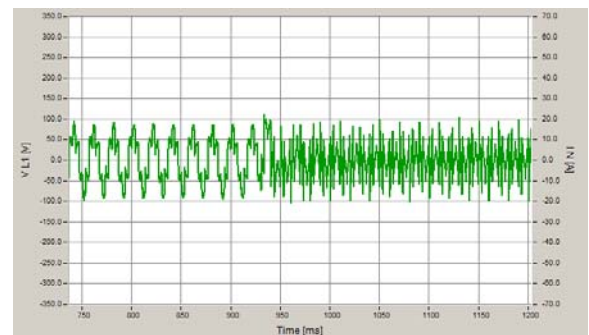

c)

Fig. 12 Variation of voltage and network current waveform(a) ,non-linear load current(b), and reference current(c) under step way change of conduction angle from 50° to 0°

They confirm practically sufficient speed of response of the developed active power filter model as well as its high efficiency of performance manifested by practically sinusoidal waveform of current drawn from the network and obtained full compensation effect ($pf=1$) [8].

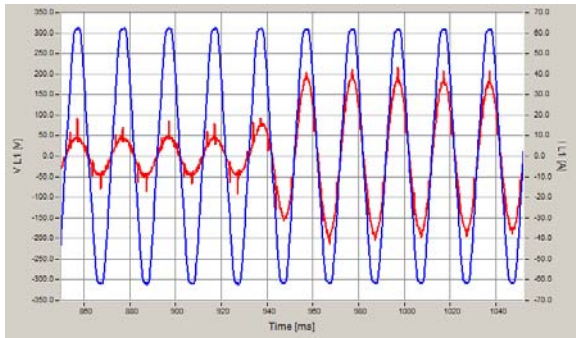

a)

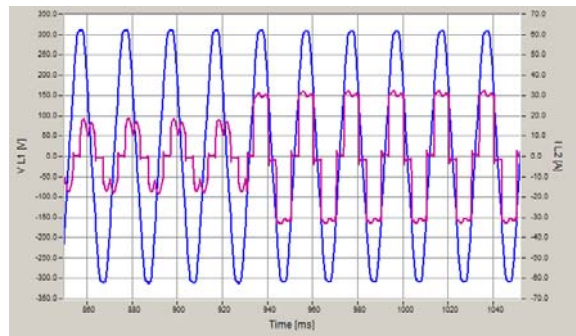

b)

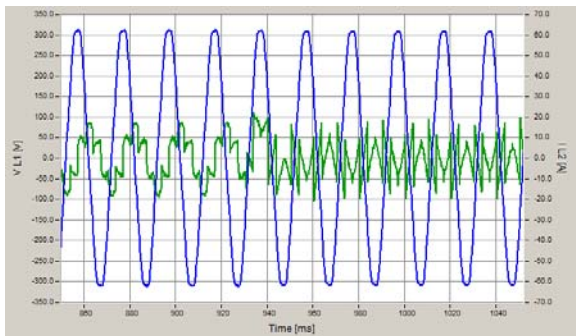

c)

Fig. 13. Extended (in time) measured quantities as in Fig. 12

Conclusions

The developed physical model of the active power filter based on a control algorithm according to CPC theory is characterized by high efficiency and sufficient speed of operation as in steady as well as in transient states both for

linear and non-linear loads. Its frequency of operation selected to 6.4kHz (PWM modulation) allows to set up a stable performance after approximately 15ms from the time of rapid deformation of the load current waveform and/or its instantaneous value. The APF application also enables to obtain full compensation effect of a reactive power ($pf=1$) regardless of the nature of the non-linearity of the supplied consumer. Conducted simulation analysis and laboratory testing fully confirmed the reliable performance and therefore, the usefulness of application of such the active power filter arrangement in electric power networks (as low as well as middle voltage) that are characterized by respective inertia due to impact of electromagnetic systems applied.

Authors:

Julian Wosik: e-mail wosik@ibemag.pl, Artur Kozłowski: e-mail artur.kozlowski@ibemag.pl, Marian Kalus: e-mail kalus@ibemag.pl, Bogdan Miedziński: e-mail bogdan.miedzinski@ibemag.pl, Institute of Innovative Technologies EMAG, 40-189 Katowice, Leopolda 31, Poland.

REFERENCES

- [1] Lyon Y.: Reactive Power and Unbalanced Circuit. *Electric World* 1920 Vol. 75 No. 25 pp 1417-1420.
- [2] Akagi H., Kazanawa Y., Nabae A.: Generalized Theory of the Instantaneous Reactive Power in Three Phase. Circuit. *Proc. JIEE-IPEC*, Tokyo 1983 pp 1375-1380.
- [3] Czarnecki L.S.: Consideration on the Reactive Power in Nonsinusoidal Situations. *IEEE Trans. Instr. Measur.* Vol. IM-34.1984.
- [4] Ginn III H. L.: Comparison of Applicability of Theories to Switching Compensator.: *Electrical Review*, No 6/2013 pp 1-10.
- [5] Czarnecki L.S.: "Currents Physical Components (CPC) in Systems with Semi-periodic Voltages and Currents" *Przegląd Elektrotechniczny*. No 6, 2015, pp25-31,
- [6] Czarnecki L.S., Bhattarai P.: " Currents Physical Components (CPC) in Three Phase Systems with Asymmetrical Voltage" *Przegląd Elektrotechniczny*, No 6, 2015, pp 40-47,
- [7] Wosik J., Kalus M., Kozłowski A., Miedzinski B.: The Efficiency of Reactive Power Compensation of High Power Nonlinear Loads. *Electronics and Electrical Engineering* .Vol 19. No 7 (2013) pp 29-32.
- [8] Wosik J.: "Active Power Compensation in Mining Networks" Ph.D. Thesis, Wrocław University of Technology, Wrocław, 2015.