

A Methodology for Tuning and Optimization of a Quadruple Tank Control System Using Firefly Algorithm in Wavelet Space

Abstract. Using more efficient tuning techniques becomes imperative, due to the increasing competitiveness in the industry. With this propose, meta-heuristics, such as Firefly Algorithm (FA), can be used to obtain the parameters of the controller according to a cost function, which should encode how good a controller is, adequately expressing the desired specifications, so that the metaheuristic employed can find the desired controller that is able to reach the response wanted. The methods traditionally used for automatic tuning of controllers present difficulties in expressing the desired specifications, being able to mapping the desired search space and allowing that the algorithm finds the proper answer. These difficulties is more evident when more complex controllers are required, as for Multiple Input Multiple Output (MIMO) problems. Aiming to solve these difficulties, a methodology using wavelet transform to describe the behavior of a controller response and its use for obtain better performance of the optimization algorithm. A case study will be done using the quadruple tank system, showing the efficiency of the methodology proposed.

Streszczenie. Stosowanie bardziej wydajnych technik strojenia staje się koniecznością ze względu na rosnącą konkurencyjność w branży. Dzięki tej propozycji meta-heurystyki, takie jak Firefly Algorithm (FA), mogą być użyte do uzyskania parametrów kontrolera zgodnie z funkcją kosztu, która powinna kodować, jak dobry jest kontroler, adekwatnie wyrażając pożądane specyfikacje, tak aby zastosowana metaheurystyka może znaleźć żądany kontroler, który jest w stanie osiągnąć żądaną odpowiedź. Metody tradycyjnie stosowane do automatycznego dostrajania sterowników stwarzają trudności w wyrażeniu pożądanych specyfikacji, możliwości odwzorowania pożądanej przestrzeni wyszukiwania i umożliwienia algorytmowi znalezienia właściwej odpowiedzi. Trudności te są bardziej widoczne, gdy wymagane są bardziej złożone kontrolery, jak w przypadku problemów z wieloma wejściami i wieloma wyjściami (MIMO). Mając na celu rozwiązanie tych trudności, opracowano metodologię wykorzystującą transformatę falkową do opisu zachowania się odpowiedzi sterownika i jej zastosowanie w celu uzyskania lepszej wydajności algorytmu optymalizacji. Zostanie przeprowadzone studium przypadku z wykorzystaniem systemu poczwórnego zbiornika, pokazujące skuteczność proponowanej metodologii. **(Metodologia dostrajania i optymalizacji poczwórnego systemu sterowania zbiornikiem za pomocą algorytmu Firefly w przestrzeni falkowej)**

Keywords: Optimization, Optimization Algorithm, Firefly Algorithm, Wavelet, MIMO, Process Control

Słowa kluczowe: optymalizacja, algorytm optymalizacji, algorytm Firefly

Introduction

The optimization of controllers become a relevant issue due to the increasing competitiveness of the industry and the search for more efficiency of production, fetching a less use of environmental resources and a greater profitability. In the scope of study, the optimization algorithm consists in a numerical techniques that minimize a numerical function, in other words, a heuristic technique that minimize a evaluate index in function of the controller parameters. Thus, we seek to find the point with the lowest evaluation index of a meta-surface that describes the evaluation index as a function of the controller parameters, in a space generated by the index and the controller parameters to be tuned.

Due to the practical impossibility of obtaining the evaluation index for all possible tunings, it is necessary to use techniques that do not require prior knowledge of the derivative of the function to be minimized, so that the group of heuristics called metaheuristics stands out. These are characterized by seeking the minimum of a function avoiding stagnating local minima, without presenting the need for prior knowledge of the function, as well as the value of its derivative. With this objective, metaheuristics evaluate a set of possible solutions, that is, it only evaluates points of the optimized function iteratively, looking more intensely for the global minimum in the region of space near the most promising possible solutions.

Using methaheuristics for tunnig and optmizing controllers is widely employed. [1] made a comparative analysis of various controller techniques for optimal control of smart Nano-grid using GA and PSO algorithms. [2] optimized cascade proportional integral - proportional derivative control for a Hybrid Power System using particle swarm optimization-gravitational search algorithm (PSO-GSA) optimization technique apply. [3] tuned a proportional-integral-derivative (PID) parameters control for a dc motor controlled via the controller area network using PSO. [4] used equilibrium optimization algorithm for automatic tunig control of interconnected power systems and [5] employed Cuckoo Search for optimal Design of controller for Wind Turbine Systems.

In this context, one of the biggest challenges in con-

trol optimization is numerically, through a evaluation function, representing how a controller response fits the intended purpose. An inappropriate choice of a evaluation function may lead the optimization algorithm to converge to a result that is supposed to be optimal, but does not constitute what is really desired. Usually, valuation indices based on system response error are used, which is not always a good strategy.

This work seeks a new index to be minimized that presents a better expression of the real problem, taking into account the behavior of the response, information partially lost with the encoding of the system response as a function of error, and through this better representation, facilitate the pursuit of the minimum by differentiating between best and worst candidates for minimums and thus better representing the metasurface of the function one wants to find the minimum.

This alternative way to measure the performance of a controller for optimization algorithms is a necessity, since data such as overshoot, rise time and settling time are not formalized when the reference signal is not a step, and indexes based on error cannot encode information contained in these step-response characteristics. Thus, a possible solution for this issue using wavelet transform will be examined in this work.

The wavelet transform is a powerful mathematical tool, which has the ability to present information from a signal in frequency and time simultaneously. This tool is consolidated to analysis when the change of the signal frequency as a function of time is relevant and is widely used in the identification of patterns and behaviors due it possibility to describe signal in frequency and time simultaneously. In this context, [6] used wavelet for spectral analysis of vibration processes at hydropower units, [7] apply to detecting faults in power transformers, [8] employ wavelet analysis for damage detection of long-span bridge cable structure and [9] proposed a non-decimated wavelet based multi-band ear recognition using principal component analysis and [10] used wavelet transforms for partial discharge signal detection in generators.

In this work, analysis in a wavelet space will be applied to compare the behaviors of the controlled system with the intended one, using wavelet analysis proposed is use the frequency analysis and pattern recognition simultaneously, according to the methodology presented in [11]. The tuning and optimization of controller system for a four-coupled tank system will be used as a case of study.

The algorithm used for the optimization is the meta-heuristic called Firefly Algorithm (FA), meta-heuristics are able to be applied in tuning and optimization of controller due they do not require gradient information, that is usually unknown. The FA was proposed in 1995 by Yang and Xin-She [12], this algorithm is particle swarm based algorithm, where the particles are fireflies flying considering the brightness of their bioluminescence, with which each one attracts the others.

In the second section, the classic methodology of the controller project using decouplers and proportional–integral–derivative (PID) controllers for the MIMO system like the quadruple tank will be presented. In the third, the optimization using FA. In fourth, the wavelet discrete transform and its proposed use in the optimization of controllers will be discussed. The fifth, sixth and seventh sections will show the case of study, the methodology used, results and conclusions respectively.

Project of MIMO control system using decoupler and PID controllers

In order to implement the intended automatic tuning and optimization of the controllers, understand the traditional approach for the project of control for MIMO systems is required. In this work will be used decouplers, that aim to minimize the effects that one variable exerts on the others, allowing to treat practically independent each set of input and output. This makes possible to develop a controller PID for each input and output pair.

The decoupling techniques can be ideal decoupler, simplified decoupler and inverted decoupler. The choice of one of these methods is a relatively complex task since each technique has its advantages and limitations [13]. The ideal decoupler give a perfect decoupling of system, but it needs matrix inversion to be projected. The simplified decoupler loses precision, but it does not demand matrix inversion, however it usually leads to complex elements in the equivalent decoupled systems. In this work, the inverted decoupler proposed by Shinkey [14] will be used since it avoids the numerical issues of matrix inversion and complex number in automatic tuning.

The system decoupling is implemented considering a matrix $C(s)$ formed by the controllers for each input and output pair and with a decoupling block or compensator $D(s)$, which aims to make the controllers observe the equivalent process $Q(s)$, which consists of a set of independent processes. Thus, the transfer function matrix $D(s)$ aims to introduce dynamics that cancel the interactions between the process variables, allowing an independent control to be made for each of the system's meshes [15]. The inverted decoupler present the arrangement of this elements in the decoupler structure shown in Figure 1. Thus $D(s)$ and $Q(s)$ can be calculated as:

$$(1) \quad Q(s) = \begin{bmatrix} q_1(s) \\ q_2(s) \end{bmatrix} = \begin{bmatrix} G_{11}(s) \\ G_{22}(s) \end{bmatrix}$$

$$(2) \quad D(s) = \begin{bmatrix} d_1(s) \\ d_2(s) \end{bmatrix} = \begin{bmatrix} \frac{G_{12}(s)}{G_{11}(s)} \\ \frac{G_{21}(s)}{G_{22}(s)} \end{bmatrix}$$

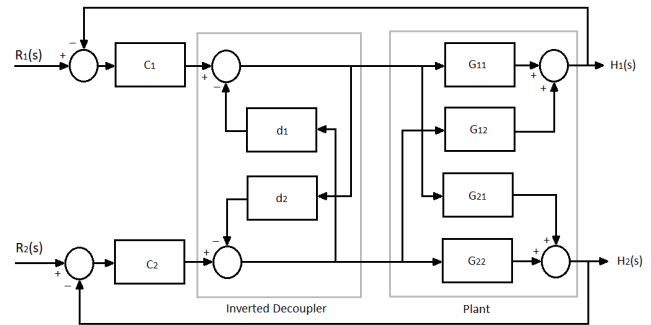

Fig. 1. Structure of an inverted decoupler for a system with two inputs and two outputs.

Tuning and optimization using FA

The use of meta-heuristics for tuning and optimization as proposed is advantageous over the approach shown in the previous section, since this has some limitations such inaccuracy of system representation including those introduced by the linearization and the subsequent decoupling for project of the control system. This inaccuracy can result in an unexpected and inadequate result in some cases. Metaheuristic can be used to overcome these limitations.

In this context, the firefly algorithm is a metaheuristic based on the flight of fireflies considering the brightness of their bioluminescence. The information to be optimized is encoded in the form of positions in a multidimensional space, each firefly being contained not only in that space but also in motion in it. Each firefly is evaluated according to a pre-defined cost function that will be expressed by its attractiveness or intensity of its brightness. The algorithm assumes three premises: 1) Each firefly can be attracted by all other fireflies; 2) The attractiveness of each firefly is proportional to its brightness, being attracted to the one it perceives to be brighter than it, but the perception of the intensity of the brightness reduces with the increase of the distance between them; 3) If there are no brightest fireflies, the movement will be random.

The Firefly Algorithm operation can be understood observing the diagram expressed in Figure 2. The update for each pair of fireflies is given by Equation 3.

$$(3) \quad x_i(n+1) = x_i(n) + \beta e^{-\gamma r_{ij}^2} (x_j(n) - x_i(n)) + \alpha \epsilon(n)$$

In the iteration, x_i and x_j are the positions of the fireflies i and j respectively, forming a pair of fireflies, ϵ is a random vector with Gaussian distribution and α , β and γ are parameters that determine the speed of convergence, the factor of luminosity perception reduction according to distance and the factor of randomness respectively. While r_{ij} is the Euclidean distance between fireflies i and j .

0.1 Classic Evaluation of Controllers

The evaluation indexes establish a criterion to evaluate the performance of controllers. When used in optimization, this index should correctly indicate if one solution is better than the other, allowing to optimization algorithm find the intended response. Several indexes are found in the literature for this

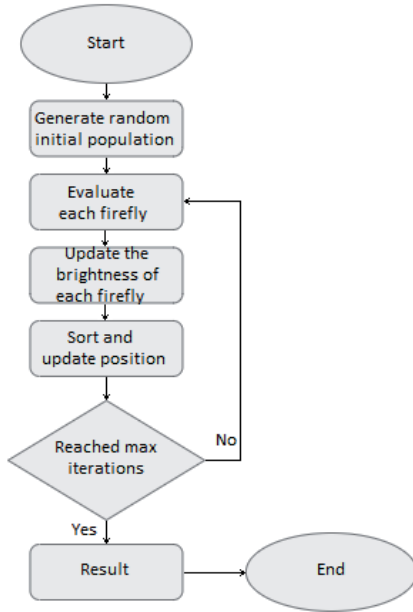

Fig. 2. Flowchart of the firefly Algorithm

purpose, the most common are those involving the integration of the error in relation to the setpoint, for examples: Integral Absolute Error ($IAE = \frac{1}{L} \sum_{n=1}^L |e(n)|$), Integral of Time Weighted Absolute Error ($ITAE = \frac{1}{L} \sum_{n=1}^L n|e(n)|$), Integral Squared Error ($ISE = \frac{1}{L} \sum_{n=1}^L e(n)^2$). Where $e(n)$ represents the error, n expresses the time instant and L represents the total number of samples.

Other possibilities were the use of some step-response characteristics like overshoot, rise time and settling time. However, the reference signal is not always compatible with a step, due to this big limitation this indexes will not be analyzed in this work.

Analysis in Wavelet Space

The Fourier transform provides information on the frequencies of a signal at all instants of time, providing the frequency spectrum of the signal. This information is independent of when the component appears, which is not suitable for some applications. Otherwise, the wavelet transform proposed for [16], allows the analysis of the signal in different frequencies with different resolutions, representing it in wavelet space, that shows frequency and time simultaneously. The wavelet transform is designed to give a high resolution of time and low resolution of frequency for high frequencies, and high resolution of frequency and low resolution of time for low frequencies. This is especially suitable when the signal has high-frequency components with short durations and the low-frequency components have a long duration, what usually happens in system of control.

The mother wavelet is the wavelet function used as a prototype to generate the other functions used as the windows of the wavelet transform, using its scale change, compression or expansion and translation. To be considered a wavelet the function $\Psi(t)$ must has the total area under its curve 0 and its energy finite. Since the discrete equivalents of a and b are respectively j and k , the discrete wavelet transform $C(a, b)$ of the function $f(n)$ is shown in Equation 4 [17]:

$$\begin{cases} C(a, b) = C(j, k) = \sum_{n \in Z} f(n) \Psi_{j, k}(n) \\ \Psi_{j, k}(n) = a_o^{-\frac{j}{2}} \Psi(a_o^{-j} n - k b_o), a_o > 1; b_o > 0. \end{cases} \quad (4)$$

The discrete wavelet transform has redundancies that generate a high computational cost, [18] optimized the representation removing the redundancies of the pyramidal coding that form the wavelet space, allowing the transform to be implemented by a bank of low-pass and high-pass filters [16]. The most usual choice is to make a dyadic sampling of the coefficients, that is, choose $a = 2$ and $b_o = 1$. Where the output of each filter is subsampled by a factor of two. This process can be described by Equation 5.

$$\begin{cases} a(n) = x(n) * g(n) = \sum_{k=-\infty}^{\infty} x(k) g(2n - k) \\ d(n) = x(n) * h(n) = \sum_{k=-\infty}^{\infty} x(k) h(2n - k) \end{cases} \quad (5)$$

Where $d(n)$ and $a(n)$ are the high-pass and low-pass filter outputs subsampled by a factor of 2 respectively, with passband $g(n)$ and the high pass $h(n)$. The sequences $d(n)$ and $a(n)$ are also known as detail and approximation of the $x(n)$ signal respectively.

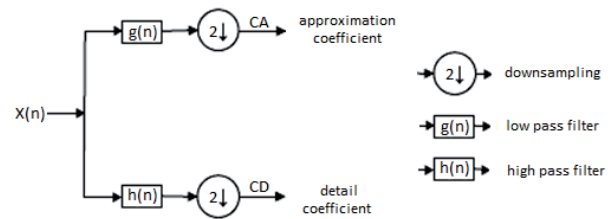

Fig. 3. Block diagram of the filter that implements the discrete wavelet transform.

The ability to show the frequency of a signal over time can be used in the evaluation and design of controllers since transient and steady state have different frequencies. Thus, the smoothness of the response can be evaluated. Thus, we can propose an evaluation function W , given by:

$$(6) \quad W = k_0 \cdot \sum (|Ca_r - Ca_y|) + \sum_{n=1}^l k_n \cdot \sum (|Cdn_r - Cdn_y|)$$

In this, l is the number of analysed levels, Ca_r are the approximation coefficients and Cd_r are the detail coefficients of the system reference signal; Cdn_y are the coefficients of detail of the output signal in n level; Cdn_r , those of the reference signal; and k_n are weights used in weighting the relevance of the coefficients in n level. In choosing these weights, we must take into consideration, the difference of magnitude, the intended behavior. This strategy is mathematically similar to that used to measure the similarity of signals of different natures comparing the descriptors of them as in [19][20][21][22]. Since only transient and steady state are analyzed $l = 1$:

$$(7) \quad W = k_0 \cdot \sum (|Ca_r - Ca_y|) + k_1 \cdot \sum (|Cd_{1r} - Cd_{1y}|)$$

If k_1 is zero, W will present a value corresponding to the IAE. Increasing the number of levels analyzed open

other possibilities as analysis of the rejection of measurement noise and disturbance if it is possible to isolate the frequency band of its occurrence, this will be studied in future works.

Quadruple Tank System

Storing a liquid in a tank and pumping it to another tank for processing are routines in industry [23]. The methodology proposed is quite adequate to be used in the process of quadruple coupled tanks, since it is often used as a benchmark and it is well known and has well known modeling, on the other hand it is relatively complex because it is a nonlinear MIMO system, what enables system simulations and justifies the use of more elaborate strategies respectively. This work aim to obtain the level control of the bottom tanks in the system show in Figure 4 with constants shown in Table 1.

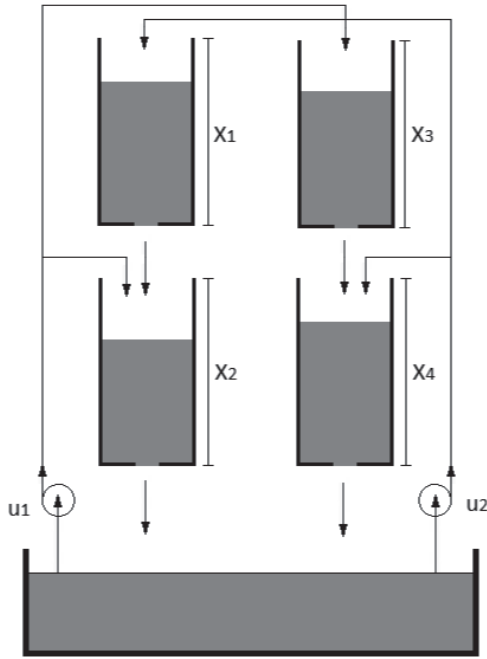

Fig. 4. Quadruple tank

Table 1. Constants used in modeling the coupled tank system.

Símbolo	Descrição	Valor	Unidade
K_{m1}	Constant of pump 1 flow	3.3	$\frac{cm^2}{s \cdot \sqrt{cm}}$
K_{m2}	Constant of pump 2 flow	4.6	$\frac{cm^3}{s \cdot \sqrt{cm}}$
a_1	Tank 1 outlet area	0.178	cm
a_2	Tank 2 outlet area	0.178	cm
a_3	Tank 3 outlet area	0.178	cm
a_4	Tank 4 outlet area	0.178	cm
A_1	Cross-sectional area of tank 1	15.25	cm^2
A_2	Cross-sectional area of tank 2	15.25	cm^2
A_3	Cross-sectional area of tank 3	15.25	cm^2
A_4	Cross-sectional area of tank 4	15.25	cm^2
g	gravity	981	cm/s^2

Since x_1, x_2, x_3 and x_4 are the fluid height, u_1 and u_2 are the input signals for the pumps and the outputs are chosen, y_1 and x_2 are the levels of the two bottom tanks. By mass balance the following equations can be obtained:

$$\begin{cases} \frac{dx_1(t)}{dt} = \frac{K_{m1}}{A_1} u_1(t) - \frac{a_1}{A_1} \sqrt{2gx_1(t)} \\ \frac{dx_2(t)}{dt} = \frac{K_{m2}}{A_2} u_2(t) + \frac{a_1}{A_2} \sqrt{2gx_1(t)} - \frac{a_2}{A_2} \sqrt{2gx_2(t)} \\ \frac{dx_3(t)}{dt} = \frac{K_{m2}}{A_3} u_2(t) - \frac{a_3}{A_3} \sqrt{2gx_3(t)} \\ \frac{dx_4(t)}{dt} = \frac{K_{m1}}{A_4} u_1(t) + \frac{a_3}{A_4} \sqrt{2gx_3(t)} - \frac{a_4}{A_4} \sqrt{2gx_4(t)} \\ y_1 = x_4 \\ y_2 = x_2 \end{cases} \quad (8)$$

Linearizing the above system with the operating point where $u_1(t) = u_{10}, u_2(t) = u_{20}, x_1(t) = x_{10}, x_2(t) = x_{20}, x_3(t) = x_{30}$ and $x_4(t) = x_{40}$, then, the system can be expressed as:

$$\begin{cases} \dot{\mathbf{x}} = \mathbf{A}\mathbf{x} + \mathbf{B}\mathbf{u} \\ \mathbf{y} = \mathbf{C}\mathbf{x} + \mathbf{D}\mathbf{u} \end{cases} \quad (9)$$

$$\begin{cases} \mathbf{A} = \begin{bmatrix} -\frac{a_1}{A_1} \sqrt{\frac{g}{2x_{10}}} & 0 & 0 & 0 \\ \frac{a_1}{A_2} \sqrt{\frac{g}{2x_{10}}} & -\frac{a_2}{A_2} \sqrt{\frac{g}{2x_{20}}} & 0 & 0 \\ 0 & 0 & -\frac{a_3}{A_3} \sqrt{\frac{g}{2x_{30}}} & 0 \\ 0 & 0 & \frac{a_3}{A_4} \sqrt{\frac{g}{2x_{30}}} & -\frac{a_4}{A_4} \sqrt{\frac{g}{2x_{40}}} \end{bmatrix} \\ \mathbf{B} = \begin{bmatrix} \frac{k_{m1}}{A_1} & 0 \\ 0 & \frac{k_{m2}}{A_2} \\ 0 & \frac{k_{m2}}{A_3} \\ \frac{k_{m1}}{A_4} & 0 \end{bmatrix}, \quad \mathbf{C} = \begin{bmatrix} 0 & 0 & 0 & 1 \\ 0 & 1 & 0 & 0 \end{bmatrix}, \quad \mathbf{D} = \mathbf{0} \end{cases} \quad (10)$$

Implementation and Results

In order to optimize the control system, a computational routines of FA used to optimize the of the controllers $C_1(s)$ and $C_2(s)$ was implemented in Matlab, both are PI controlles, in addition to the parameters denominated $p_{11}, p_{12}, p_{13}, p_{21}, p_{22}$ and p_{23} , which are the parameters of the decouplers $d_1(s)$ and $d_2(s)$. To find suitable values for these parameters and optimize them it is necessary to initially encode them as positions in a multidimensional space of possible solutions.

$$(11) \quad d_1(s) = \frac{p_{11}}{p_{12}s + p_{13}}$$

$$(12) \quad d_2(s) = \frac{p_{21}}{p_{22}s + p_{23}}$$

The parameters $\alpha = 0.05, \beta = 1$ and $\gamma = 1$ were chosen in FA. The FA was performed with 31 fireflies in the course of 100 iterations. The goal of the FA is find a response with a rapid rise and with fewer high-frequency oscillations in the transient using the analyse of wavlet space for this. This analyse can be made using the sum of index proposed previously applied to each of the lower tanks as the cost function of FA. The index was implemented in Matlab using wavelet decomposition of Matlab with its standard discretization, using the Daubechies 1 family of filters. Since the system to be controlled is MIMO the index

For analysis the result will be compared with that found with the classic evaluation indexes shown previously. In addition, the influence of the values of the parameters k_0 and k_1

of the W index on the behavior of the systems will be studied. Figure 5 shows y_1 , Figure 6 shows y_2 and Figure 7 and 8 show u_1 and u_2 respectively.

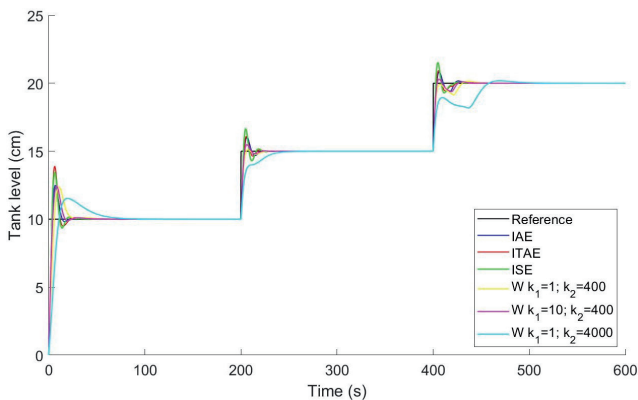

Fig. 5. Level of bottom tank X_2

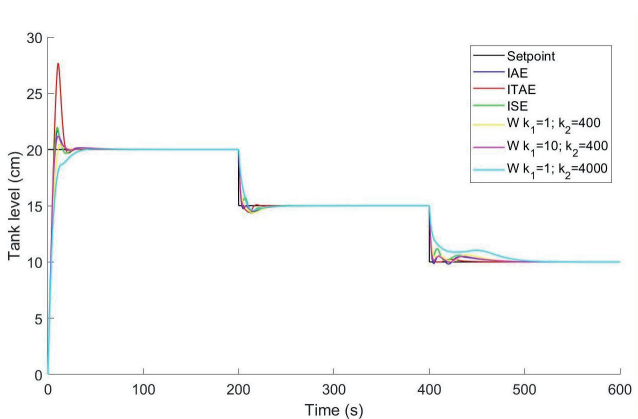

Fig. 6. Level of bottom tank X_4

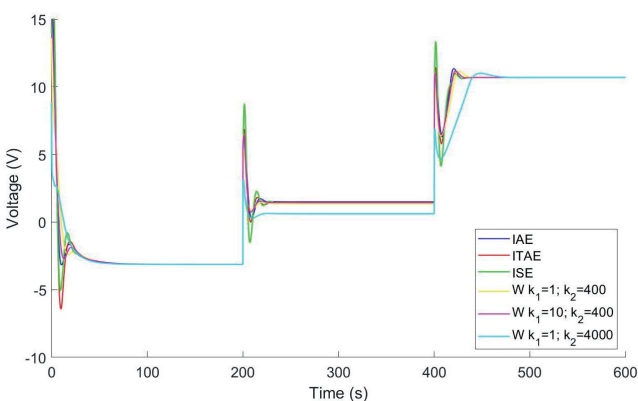

Fig. 7. Input in first pump u_1

For a better analysis, the output y_1 will be presented in Figure 9 for the time between $0s$ and $100s$. For the same purpose, for the time between $200s$ and $250s$, the output y_2 is shown in Figure 10. The output y_1 is expressed in Figure 11 for time values between $400s$ and $500s$.

The output y_2 was expressed in Figure 12, 13 and 14 for the time values between $0s$ and $100s$, between $200s$ and $300s$, and between $400s$ and $500s$ respectively.

As rapid response with soft transient and quickly arriving at the reference was the intended, the W index shown better response after observing the graphs presented. Only ITAE response seems to present generally, for the most part of steps, a really slow and inadequate response.

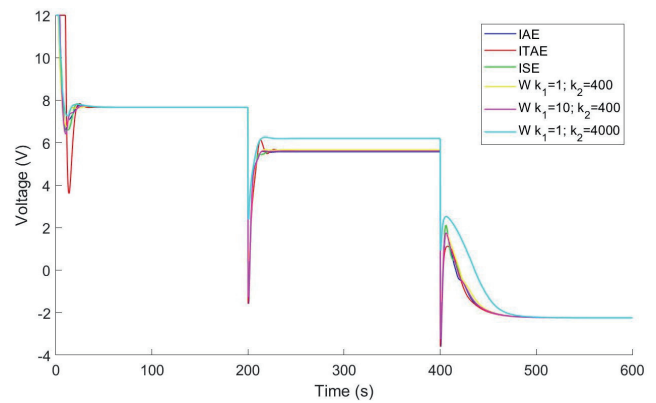

Fig. 8. Input in second pump u_2

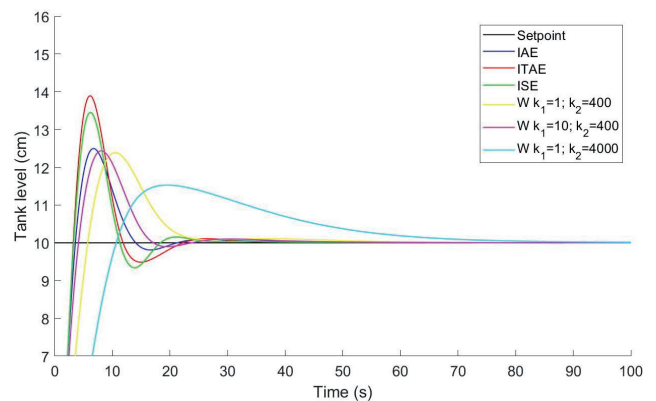

Fig. 9. Level of bottom tank X_2 between $0s$ and $100s$.

The increase of parameter k_0 , taking into account the $(k_0; k_1) = (10; 400)$ led meta-heuristics to find, controllers that leads to more oscillations of higher frequencies, while higher value of parameter k_1 , which can be observed when $(k_0; k_1) = (1; 4000)$, generally led to soft response. Thus, in the case study, for the presented values, it was observed that larger weights, proportionally, for parameter k_1 inhibit a greater number of oscillations of higher frequencies, which, in general, led to the absence or small overshoot. However, this did not necessarily result in a slower response for higher values of k_1 .

When k_1 this parameter was privileged the response found by the tuned controllers tended or to be slower so that the system response would slowly follow the reference without greater oscillations, or quickly follow the reference and remain stable on it. These slower responses also result in the reduction of high-frequency oscillations. This result is ex-

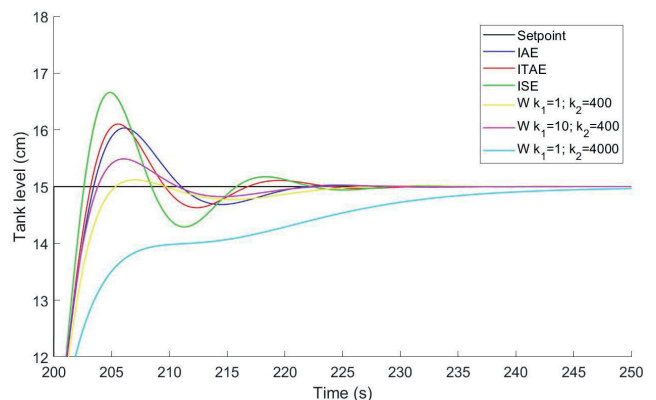

Fig. 10. Level of bottom tank X_2 between $200s$ and $250s$.

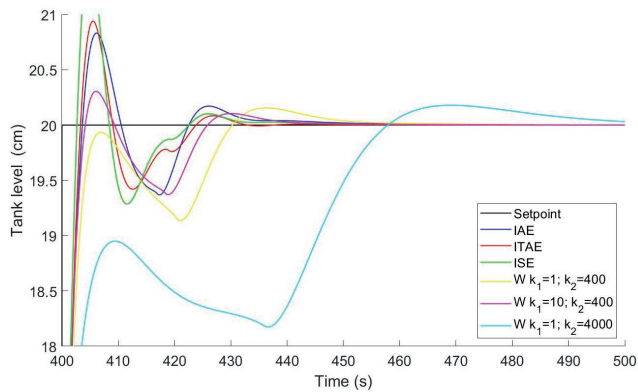

Fig. 11. Level of bottom tank X_2 between 400s and 500s.

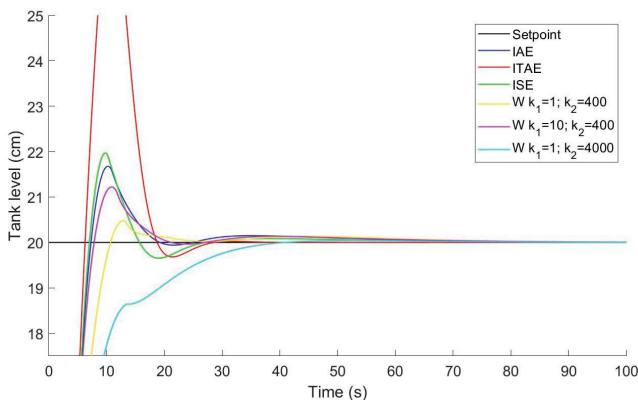

Fig. 12. Level of bottom tank X_4 between 0s and 100s.

pected since the parameter k_1 corresponds to the coefficient of detail that presents the information of higher frequencies of the analyzed signal. The parameter k_0 , on the other hand, take into account the general form of the wave, favoring the low frequencies.

The slower responses obtained for higher values of k_1 may not be adequate, as they take longer to follow the reference the high and low-frequency components of k_1 are expected to be worse, so to have a balance between these two parameters so that the response in high and low frequency, referring to reference tracking and high frequency, referring to fewer oscillations, are adequate.

Conclusion

According to what was observed, it is possible to observe the feasibility of using the wavelet transform and its multilevel analysis, already widely used in the most di-

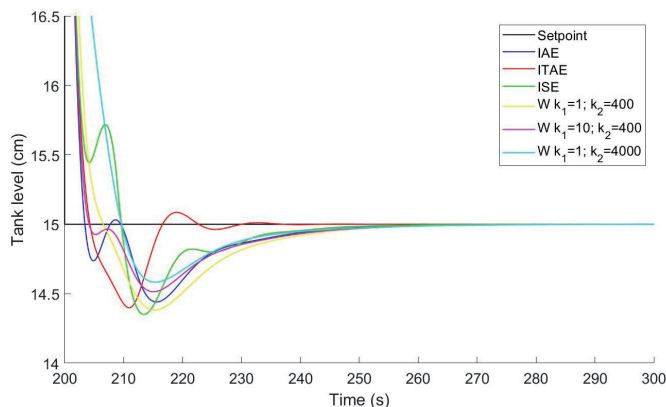

Fig. 13. Level of bottom tank X_4 between 200s and 250s.

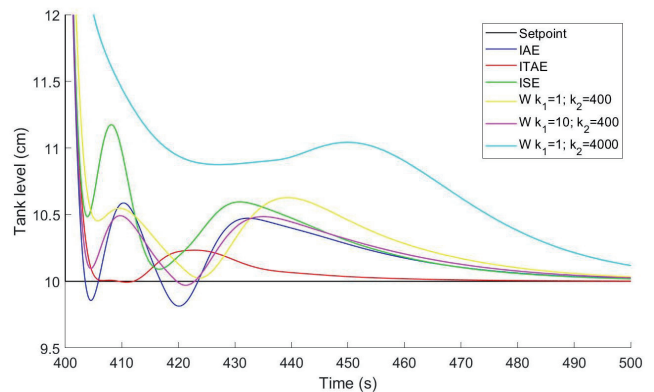

Fig. 14. Level of bottom tank X_4 between 400s and 500s.

verse applications of signal analysis, in evaluation for meta-heuristics applied in the tuning of controllers. During the tests performed to compare different cost functions for evaluation for FA. The applied methodology demonstrated to allow the optimization taking into account the wanted behavior for the controller. From the results obtained, it can be observed that the proposed evaluation function managed to adequately map the performance of the controllers to the meta-heuristics, pointing satisfactorily to the best controllers.

Although the study carried out in this work has been applied only to the analysis of the high-frequency oscillations, associated to the transient, it is expected that it can be extended to the analysis of rejection to the perturbation and the noise what will be analyzed in future works.

Authors: Eng. M. Sc. André Henrique Matias Pires, Prof. D. Sc. Fábio Meneghetti Ugulino de Araújo, Department of Computer Engineering and Automation, Technology Center, Federal University of Rio Grande do Norte, R. das Engenharias, SN, Natal, Rio Grande do Norte, Brazil, email: andrepires@dca.ufrn.br

REFERENCES

- [1] S. Yousaf, A. Mughees, M. G. Khan, A. A. Amin and M. Adnan, "A Comparative Analysis of Various Controller Techniques for Optimal Control of Smart Nano-Grid Using GA and PSO Algorithms," in *IEEE Access*, vol. 8, pp. 205696-205711, 2020, doi: 10.1109/ACCESS.2020.3038021.
- [2] V. Veerasamy et al., "A Hankel Matrix Based Reduced Order Model for Stability Analysis of Hybrid Power System Using PSO-GSA Optimized Cascade PI-PD Controller for Automatic Load Frequency Control," in *IEEE Access*, vol. 8, pp. 71422-71446, 2020, doi: 10.1109/ACCESS.2020.2987387.
- [3] Z. Qi, Q. Shi and H. Zhang, "Tuning of Digital PID Controllers Using Particle Swarm Optimization Algorithm for a CAN-Based DC Motor Subject to Stochastic Delays," in *IEEE Transactions on Industrial Electronics*, vol. 67, no. 7, pp. 5637-5646, July 2020, doi: 10.1109/TIE.2019.2934030.
- [4] AGWA, Ahmed Mahmoud. *Equilibrium optimization algorithm for automatic generation control of interconnected power systems*. *Przeglad Elektrotechniczny* 96.9 (2020): 143-148.
- [5] CHEUNPIROM, Montree, and Deacha PUANGDOWNRE-ONG. *Optimal Design of PI D A Controller for Wind Turbine Systems by Cuckoo Search*. *Przeglad Elektrotechniczny* 98.7 (2022): 110-115.
- [6] KUKHARCHUK, Vasyil V., et al. *Discrete wavelet transformation in spectral analysis of vibration processes at hydropower units*. *Przeglad elektrotechniczny* 93.5 (2017): 65-68.
- [7] S. Pant, R. K. Nema and S. Gupta, "Detecting Faults in Power Transformers Using Wavelet Transform," 2021 IEEE 2nd International Conference On Electrical Power and Energy Systems (ICEPES), 2021, pp. 1-5, doi: 10.1109/ICEPES52894.2021.9699483.
- [8] L. Ke, "Damage detection method of long-span bridge cable structure based on wavelet packet analysis," 2022 14th International Conference on Measuring Technology and

Mechatronics Automation (ICMTMA), 2022, pp. 326-330, doi: 10.1109/ICMTMA54903.2022.00069.

- [9] M. M. Zarachoff, A. Sheikh-Akbari and D. Monekosso, "Non-Decimated Wavelet Based Multi-Band Ear Recognition Using Principal Component Analysis," in *IEEE Access*, vol. 10, pp. 3949-3961, 2022, doi: 10.1109/ACCESS.2021.3139684.
- [10] I. Sornsen, C. Suppitaksakul and R. Kitpaibontawee, "Partial Discharge Signal Detection in Generators Using Wavelet Transforms," 2021 International Conference on Power, Energy and Innovations (ICPEI), 2021, pp. 195-198, doi: 10.1109/ICPEI52436.2021.9690682.
- [11] Pires, André Henrique Matias. Análise multinível wavelet como fitness na sintonia de controladores utilizando meta-heurísticas. MS thesis. Brazil, 2017.
- [12] X.-S. Yang, "Firefly algorithms for multimodal optimization," in *International symposium on stochastic algorithms*. Springer, 2009, pp. 169-178.
- [13] E. Gagnon, A. Pomerleau, and A. Desbiens, "Simplified, ideal or inverted decoupling?" *ISA transactions*, vol. 37, no. 4, pp. 265-276, 1998.
- [14] F. Shinskey, *Process-control systems: application, design, adjustment*, ser. Chemical engineering series. McGraw-Hill, 1988. [Online]. Available: <https://books.google.com.br/books?id=PE1IAg3ks0YC>
- [15] J. Garrido, F. Vazquez, and F. Morilla, "An extended approach of inverted decoupling," *Journal of Process Control*, vol. 21, no. 1, pp. 55-68, 2011.
- [16] S. G. Mallat, "A theory for multiresolution signal decomposition: the wavelet representation," *Pattern Analysis and Machine Intelligence, IEEE Transactions on*, vol. 11, no. 7, pp. 674-693, 1989.
- [17] M. N. Do and M. Vetterli, "Wavelet-based texture retrieval using generalized gaussian density and kullback-leibler distance," *IEEE transactions on image processing*, vol. 11, no. 2, pp. 146-158, 2002.
- [18] M. Vetterli and C. Herley, "Wavelets and filter banks: Theory and design," *IEEE transactions on signal processing*, vol. 40, no. ARTICLE, 1992
- [19] I. Darilmaz, "Wavelet based similarity measurement algorithm for seafloor morphology," Ph.D. dissertation, Massachusetts Institute of Technology, 2006.
- [20] R. Kronland-Martinet, J. Morlet, and A. Grossmann, "Analysis of sound patterns through wavelet transforms," *International journal of pattern recognition and artificial intelligence*, vol. 1, no. 02, pp. 273-302, 1987
- [21] L. Zhang, L. Zhang, X. Mou, and D. Zhang, "Fsim: A feature similarity index for image quality assessment," *IEEE transactions on Image Processing*, vol. 20, no. 8, pp. 2378-2386, 2011.
- [22] J. Lin, "Feature extraction of machine sound using wavelet and its application in fault diagnosis," *NDT e International*, vol. 34, no. 1, pp. 25-30, 2001.
- [23] B. W. Bequette, *Process control: modeling, design, and simulation*. Prentice Hall Professional, 2003.