

# On feedback linearization of input constrained systems

**Abstract.** *The main idea and purpose of this paper is to draw attention to some practical aspect of applying the method of input-output feedback linearization to objects with specific input constraints. It has been shown that an unreflective application of linearization by feedback to systems with constraints, especially positive systems, may affect the efficiency and effectiveness of the entire control strategy. The paper provides conditions to verify when a dynamic object with an input constraint to nonnegative control signals can be correctly input-output feedback linearized. The issues discussed are illustrated with appropriate examples.*

**Streszczenie.** *Główną ideą i celem tego artykułu jest zwrócenie uwagi na pewien praktyczny aspekt zastosowania metody linearyzacji poprzez sprzężenie zwrotne typu wejście-wyjście do obiektów o określonych ograniczeniach sygnałów wejściowych. Wykazano, że bezrefleksyjne zastosowanie linearyzacji poprzez sprzężenie zwrotne do układów z ograniczeniami, zwłaszcza układów dodatnich, może wpłynąć na efektywność i skuteczność całej strategii sterowania. W artykule przedstawiono warunki do sprawdzenia, kiedy obiekt dynamiczny z ograniczeniem wejściowym do nieujemnych sygnałów sterujących może być poprawnie zlinearyzowany ze sprzężeniem zwrotnym wejście-wyjście. Omawiane zagadnienia zilustrowane są odpowiednimi przykładami. (O linearyzacji obiektów sterowania z ograniczonymi sygnałami wejściowymi)*

**Keywords:** input-output feedback linearization, input constrained systems

**Słowa kluczowe:** linearyzacja ze sprzężeniem zwrotnym od wyjścia, układy z ograniczonymi sygnałami wejściowymi

## Introduction

In the real world there is a lot of objects of different nature we want to control. What characterizes many of them is the fact that values of acceptable input signals are limited. A broad class of systems that have natural restrictions on the values of input signals are positive systems, where input signals can only take nonnegative values, and the impact on them is possible also only by means of nonnegative control signals [3]. Such systems occur in different areas of life such as chemical engineering, medicine, economy, social science and also electrical engineering. For example, in treating a disease by applying some pharmacology, the dosing of medicament occur only with nonnegative amounts and it is not possible to apply a negative dose of the drug. Thus, we may see positive systems such as systems with constraints imposed on control signals being only nonnegative. This fact can cause some limitations in the steering of the control system and reduce the efficiency of the control. Indeed, for example, in the case of a set point control, the controller, for example proportional (with positive gain), may generate negative control signals which are either ignored by the plant or, perhaps, destructive to it. Thus, operation of the control system during the generation of negative control signals seems inadvisable (although sometimes inevitable).

A lot of systems we want to control are nonlinear. Very often in order to steer them effectively, we linearize the nonlinear model of dynamics' plant and then dealing with linear system we develop and next apply known linear control methods. A relatively popular method of linearization is feedback linearization, which, in contrast to the popular Taylor linearization technique, results with exactly linear system. Such a linearized system is obtained mainly by generating a suitable feedback applied on plant's input. Again, if the object is a positive system, the input signals it tolerates are only nonnegative. If the calculated linearizing feedback (treating as a whole control law) takes negative values at certain time-intervals, such a feedback signal has no effect on the object, failing to realize correct linearization. Thus, it would be advisable to consciously apply the linearization method by, for example, developing nonnegative linearizing feedbacks (if at all possible) or, first of all, theoretically verifying the possibility of obtaining correct linearizing feedbacks.

While the generation of negative control signals by the controller is often unavoidable through, for example, the aforementioned negative error values, it may be worth considering a control method other than using linearization with

feedback possibly generating negative input signals.

To the best of the author's knowledge, despite the existing results on the linearization with input constraints (formulated in the form of optimization methods and algorithms), not much attention has been paid to depicting the conditions themselves imposed on the external control expressed in relation to the dynamics of the control object, i.e., the relation illustrating the transformation of time-constant constraints on inputs of the object into state-dependent constraints imposed on the external control. In the paper [5] an input-output linearization strategy for constrained nonlinear processes based on model predictive control is proposed. The paper [1] introduces a technique for handling input constraints within a real-time model predictive control scheme, where the plant model employed is a class of dynamic neural networks. Work [4] deals with robust feedback linearization control of nonlinear systems with matched uncertainties and subject to constraints on the control input. An appropriate pole placement method for the linearized system to ensure the satisfaction of input constraints is proposed. A class of discrete-time control systems with input constraints were also studied, e.g., in [6], where handling with model predictive control approach is presented.

In light of the above, the purpose of this work is to present in a transparent way some conditions that should be met by a control object and applied input-output (I-O) linearizing feedback (together with a control law) in order for the closed linearized system to be correct, i.e. the resulting control law to generate nonnegative input signals only.

## Main results

Let us consider a SISO nonlinear control object of the form [2]:

$$(1) \quad \Sigma: \begin{cases} \dot{x} = f(x) + g(x)u \\ y = h(x), \end{cases}$$

where  $x \in \mathbb{R}^n$  is the state vector,  $u \in \mathbb{R}$  is a scalar input,  $y \in \mathbb{R}$  is a scalar output,  $f(x) = (f_1(x), \dots, f_n(x))^T$  and  $g(x) = (g_1(x), \dots, g_n(x))^T$  are smooth vector fields, i.e.,  $f_i(x), g_i(x) \in C^\infty$ ,  $1 \leq i \leq n$ , and  $h(x) \in C^\infty$  is a smooth scalar function.

Taking  $z_1 = h(x)$  as the first linearizing coordinate and applying to  $\Sigma$  the feedback of the form

$$(2) \quad u = \alpha(x) + \beta(x)v, \quad \beta(x) \neq 0,$$

where  $v \in \mathbb{R}$  is a new input, and

$$\alpha(x) = -\frac{L_f^r h(x)}{L_g L_f^{r-1} h(x)} \quad \text{and} \quad \beta(x) = \frac{1}{L_g L_f^{r-1} h(x)}$$

with  $r \in \mathbb{N}$  being a well defined locally relative degree of  $\Sigma$ , we arrive at the following linearized system

$$\bar{\Sigma}^r: \begin{aligned} \dot{z}_1 &= z_2 \\ \dot{z}_2 &= z_3 \\ &\vdots \\ \dot{z}_r &= v \\ \dot{z}_{r+1} &= q_{r+1}(z) \\ &\vdots \\ \dot{z}_n &= q_n(z) \\ y &= z_1, \end{aligned}$$

where

$$z = \Psi(x) = \left( h(x), \dots, L_f^{r-1} h(x), \psi_{r+1}(x), \dots, \psi_n(x) \right)^T$$

with  $\psi_i(x)$ ,  $r+1 \leq i \leq n$ , calculated from the following system of partial differential equations

$$L_g \psi_i(x) = 0, \quad \text{for } r+1 \leq i \leq n,$$

and all  $x \in X' \subset X$  in neighborhood  $x^0$ , and such that  $\Psi(x)$  is a local diffeomorphism around  $x^0$ . The functions  $q_i \in C^\infty$  are  $q_i = L_f \psi_i(\Psi^{-1}(x))$  for  $r+1 \leq i \leq n$ .

Consider the control system  $\bar{\Sigma}$  with input signals constrains  $u \in \mathbb{R}_+$ , i.e.,  $u \geq 0$ .

**Definition 1.** For  $\bar{\Sigma}$  that is I-O feedback linearizable on  $X' \subset X$  and for a fixed  $x \in X'$ , a control value  $v \in \mathbb{R}$ , is called  $u$ -positive at  $x$  if (2) gives  $u \geq 0$ .

As it states above Definition 1 the required property is a property of  $v$  for a fixed  $x \in X'$ .

**Proposition 1.** For  $\bar{\Sigma}$  that is I-O feedback linearizable on  $X' \subset X$ , a control value  $v \in \mathbb{R}$  is  $u$ -positive at  $x \in X'$  if

$$v \geq L_f^r h(x) \quad \text{when } L_g L_f^{r-1} h(x) > 0$$

and

$$v \leq L_f^r h(x) \quad \text{when } L_g L_f^{r-1} h(x) < 0.$$

*Proof.* If for a fixed  $x \in X'$  we have  $v \geq L_f^r h(x)$ , then  $-L_f^r h(x) + v \geq 0$ . Since  $L_g L_f^{r-1} h(x) > 0$ , we obtain

$$-\frac{L_f^r h(x)}{L_g L_f^{r-1} h(x)} + \frac{1}{L_g L_f^{r-1} h(x)} v = u \geq 0.$$

If for a fixed  $x \in X'$  we have  $v \leq L_f^r h(x)$ , then  $L_f^r h(x) - v \geq 0$ . Since  $L_g L_f^{r-1} h(x) < 0$ , so  $-L_g L_f^{r-1} h(x) > 0$ , and we obtain

$$\begin{aligned} & \frac{L_f^r h(x)}{-L_g L_f^{r-1} h(x)} - \frac{1}{-L_g L_f^{r-1} h(x)} v \\ &= -\frac{L_f^r h(x)}{L_g L_f^{r-1} h(x)} + \frac{1}{L_g L_f^{r-1} h(x)} v = u \geq 0. \end{aligned}$$

The result of Proposition 1 is illustrated in Figure 1, where different cases of the relation  $u = \alpha(x) + \beta(x)v$  for fixed  $x$  are depicted.

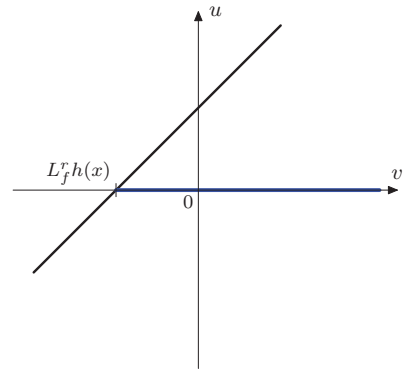

(a)  $\alpha(x) > 0$  and  $\beta(x) > 0$

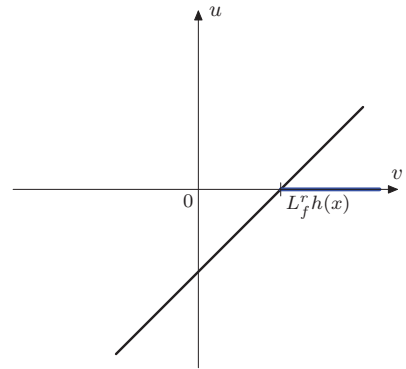

(b)  $\alpha(x) < 0$  and  $\beta(x) > 0$

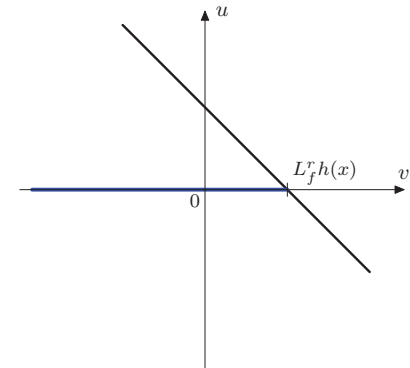

(c)  $\alpha(x) > 0$  and  $\beta(x) < 0$

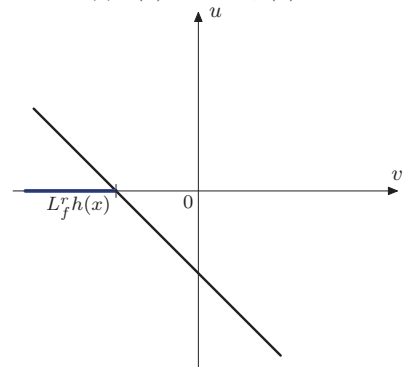

(d)  $\alpha(x) < 0$  and  $\beta(x) < 0$

Fig. 1. Graphs of affine function  $u = \alpha(x) + \beta(x)v$  for fixed  $x \in \mathbb{R}^n$  and value ranges of the control variable  $v$  providing to be  $u$ -positive

□

It is worth to notice that a given affine relation  $u = \alpha(x) + \beta(x)v$ , expressed for different fixed  $x$ , may vary between the cases (a) and (b) for  $\beta(x) > 0$  or between (c) and (d) for  $\beta(x) < 0$  of Figure 1, because the sign of  $\beta(x)$  for all  $x$  cannot change due to the smoothness of  $\beta(x)$  and the I-O feedback linearization condition  $\beta(x) \neq 0$ .

**Remark 1.** Let us assume that the system  $\Sigma$  is positive [7], which we will denote  $\Sigma_+$ , so with  $x \in \mathbb{R}_+^n$ ,  $y \in \mathbb{R}_+$ , and  $u \in \mathbb{R}_+$ . Let us denote  $\partial_i \mathbb{R}_+^n = \{x \in \mathbb{R}_+^n : x_i = 0\}$ . In particular, for  $r = 1$  and  $h(x) = x_i$ ,  $i \in \{1, \dots, n\}$ , by Proposition 1 and from the positivity ( $L_f x_i = f_i(x) \geq 0$  and  $L_g x_i = g_i(x) \geq 0$  for  $x \in \partial_i \mathbb{R}_+^n$ ) of  $\Sigma_+$  (see [7]) it follows that if  $X' \cap \partial_i \mathbb{R}_+^n \neq \emptyset$ , then  $v$  will take only nonnegative values, i.e.,

$$v \geq f_i(x) \quad \text{for all } x \in X' \cap \partial_i \mathbb{R}_+^n.$$

**Example 1.** Let us consider a tank with a pump, whose simplified dynamics are described as

$$(3) \quad \frac{d}{dt}H = -\frac{1}{A}Ca\sqrt{2g_r H} + \frac{k_p}{A}V,$$

where  $H$  denotes the liquid level in the tank,  $A$  is a cross-section area of the tank,  $a$  is a cross-section area of the outlet valve,  $C$  is a flow rate factor through the outlet valve,  $g_r$  is the gravitational acceleration,  $k_p$  is a constant coefficient and  $V$  is a pump supply voltage. Since the liquid can only be pumped into the tank and cannot be pumped out, such a tank system is, obviously, a positive system. The voltage supply takes only nonnegative values. From the observation and control point of view we are interested in controlling the liquid level  $H$ . Denoting  $x = H$  and  $u = V$  we rewrite dy-

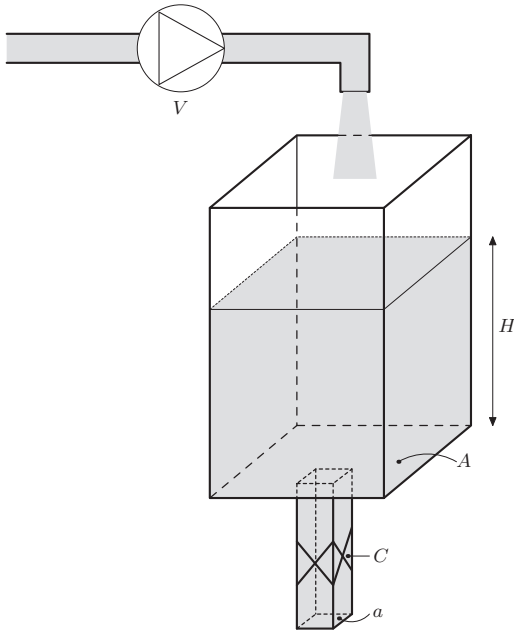

Fig. 2. Tank system

namics (3) into the following nonlinear system

$$(4) \quad \dot{x} = -\frac{1}{A}Ca\sqrt{2g_r x} + \frac{k_p}{A}u$$

$$(5) \quad y = x.$$

Model (4) may be simply linearized by means of  $z = x$ , where  $r = n = 1$ , and

$$(6) \quad u = \frac{1}{k_p}Ca\sqrt{2g_r x} + \frac{A}{k_p}v$$

into the linear form

$$\dot{z} = v.$$

Since  $L_g x = \frac{k_p}{A} > 0$  and  $L_f x = -\frac{1}{A}Ca\sqrt{2g_r x} \leq 0$  for all  $x \in \mathbb{R}_+$ , from Proposition 1 we get that

$$(7) \quad v \geq -\frac{1}{A}Ca\sqrt{2g_r x}$$

providing I-O linearizing feedback  $u$  to be nonnegative (case (a) of Figure 1). In Fig. 3 the plots of liquid level  $H$  and corresponding control signal  $u$  are presented for different values of  $v \in [L_f h, 0]$ . For  $v = L_f h$  control signal  $u(t) = 0$  and level  $H(t)$  are decreasing over time; for  $v = 0.5L_f h$  control signal  $u(t) > 0$  and level  $H(t)$  also decrease over time but slowly in comparison to  $v = L_f h$ ; for  $v = 0$  control signal  $u(t) = \frac{1}{k_p}Ca\sqrt{2g_r H_0}$  is constant and level  $H(t) = H_0$  is constant, where  $H_0$  is the initial level of liquid in time  $t = 0$ .

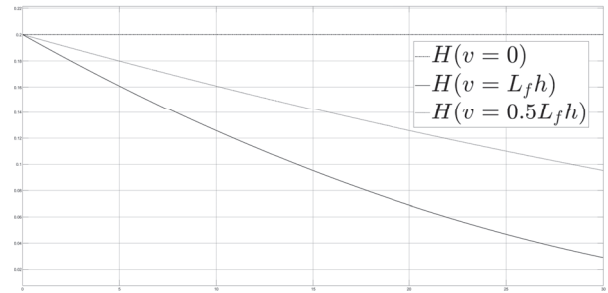

(a) Liquid level responses of linearized tank system  $\dot{z} = v$ .

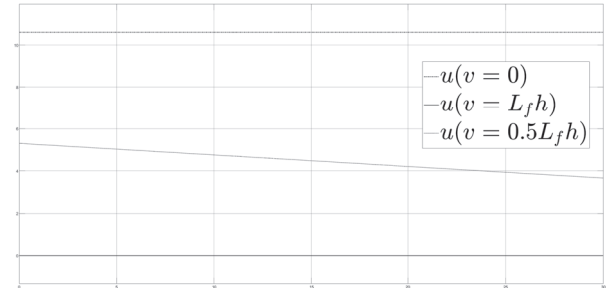

(b) Plots of control signals  $u$  of linearized tank system  $\dot{z} = v$ .

Fig. 3. Plots of signals of the linearized system  $\dot{z} = v$  for different values of  $v \in [L_f h, 0]$ .

As an aside, the positivity condition  $L_f x = -\frac{1}{A}Ca\sqrt{2g_r x} = 0$  for  $x = 0 \in \partial \mathbb{R}_+$ , and the I-O linearizing feedback (6) is nonnegative because it takes only nonnegative values for  $x = 0$  and  $v \geq 0$ .

It should be noted that the most natural and obvious providing zero steady-state error control law  $v = -z + w$ , where  $w \in \mathbb{R}_+$  is a new reference signal, should respect (7). That is,

$$u = \frac{1}{k_p}Ca\sqrt{2g_r x} + \frac{A}{k_p}(-x + w) \geq 0$$

if

$$x - \frac{Ca}{A}\sqrt{2g_r x} \leq w.$$

For  $w \leq x - \frac{Ca}{A}\sqrt{2g_r x}$ , i.e., for  $v \leq -\frac{Ca}{A}\sqrt{2g_r x}$ , the I-O linearizing feedback  $u \leq 0$ , and approaching the given reference level  $w$  is done only by gravity with zero input signal  $u = 0$ . If  $w = z$ , i.e.,  $v = 0$ , then  $\dot{z} = 0$  and the liquid level  $z(t) = z(0)$  for all  $t \geq 0$ . Thus, one cannot accelerate (with

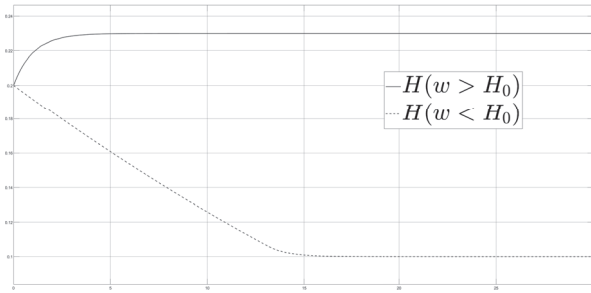

(a) Plots of liquid levels  $H$ .

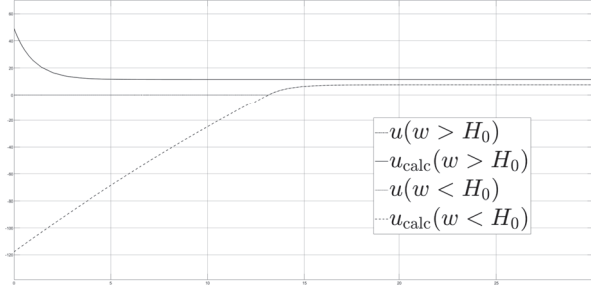

(b) Plots of control signals ( $u_{\text{calc}}$  – calculated,  $u$  – entering on tank)

Fig. 4. Plots of signals of linearized tank system  $\dot{z} = -z + w$ .

no manual change of the valve flow) the rate of lowering the liquid level in the tank (see Figure 4).

**Example 2.** Let us consider a d.c. motor in which the stator voltage  $V_s > 0$  is constant, while the rotor voltage  $V_r$  is used as a control variable  $u$  and is assumed to take only nonnegative values causing only one direction of the angular shaft rotation. Choosing as the state variable  $x_1 = I_s$  the stator current,  $x_2 = I_r$  the rotor current, and  $x_3 = \omega$  the angular velocity of rotor, we get the following state-space representation of the motor dynamics

$$\dot{x} = \begin{pmatrix} -\frac{R_s}{L_s}x_1 + \frac{V_s}{L_s} \\ -\frac{R_r}{L_r}x_2 - \frac{KL_s}{L_r}x_1x_3 \\ -\frac{F}{J}x_3 + \frac{KL_s}{J}x_1x_2 \end{pmatrix} + \begin{pmatrix} 0 \\ \frac{1}{L_r} \\ 0 \end{pmatrix} u,$$

where  $R_s$ ,  $R_r$  and  $L_s$ ,  $L_r$  are rotor and stator resistance and inductance, respectively;  $J$  is the inertia of the load,  $F$  the viscous friction constant, and  $K$  is a constant.

Choosing the angular velocity  $x_3$  as the controlled output, i.e.,  $y = x_3$ , we have

$$L_g x_3 = 0, \quad L_f x_3 = -\frac{F}{J}x_3 + \frac{KL_s}{J}x_1x_2,$$

$$L_g L_f x_3 = \frac{KL_s x_1}{JL_r},$$

so  $r = 2$ , and

$$L_f^2 x_3 = \frac{JKL_r V_s x_2 + F^2 L_r x_3}{J^2 L_r}$$

(8)

$$-\frac{JK^2 L_s^2 x_1^2 x_3 + K(FL_r L_s + JL_r R_s + JL_s R_r)x_1 x_2}{J^2 L_r}.$$

Therefore, the I-O linearizing feedback

$$u = -\frac{L_f^2 x_3}{L_g L_f x_3} + \frac{1}{L_g L_f x_3} v,$$

where  $x_1 > 0$  due to the positive stator voltages supply  $V_s > 0$ , together with the part of the new state coordinates

$$z_1 = x_3, \quad z_2 = -\frac{F}{J}x_3 + \frac{KL_s}{J}x_1x_2$$

yield the partially linearized system, with the second order linear dynamics

$$\begin{aligned} \dot{z}_1 &= z_2 \\ \dot{z}_2 &= v. \end{aligned}$$

Taking as the control objective to keep two different constant positive angular velocities periodical, we apply the following linear control law

$$v = -k_1 z_2 - k_2 (z_1 - z_1^{\text{ref}}), \quad k_1, k_2 > 0,$$

where  $z_1^{\text{ref}}(t) = \omega^{\text{ref}}(t)$  is a square periodic function, which in order to obey the constraint  $u \geq 0$  should respect

$$v \geq L_f^2 x_3,$$

where  $L_f^2 x_3$  is given by (8), because of  $\beta(x) = JL_r / KL_s x_1 > 0$ .

## Conclusion

The article presents and discusses the condition for ensuring the values of the input signals of the I-O feedback linearized system within the limits. This condition imposes restrictions on the external control signal being a component of the input signal of the object. Although the motivation to deal with the discussed issues was the existence of a wide class of positive objects, which by their nature have limitations on input signals, the results obtained in this work are not limited only to positive systems, but can also be applied to systems in which the controls can take only nonnegative values.

Additional constraints imposed on the inputs will entail additional conditions for the I-O linearizing feedback.

## Acknowledgements

Thanks to Professor Witold Respondek for the discussion and valuable comments on the manuscript.

**Authors:** Ph.D. Wiktor Malesza, Institute of Control and Industrial Electronics, Warsaw University of Technology, Koszykowa 75, 00-662 Warszawa, Poland, e-mail: wiktor.malesza@pw.edu.pl

## REFERENCES

- [1] Jiamei Deng, Victor Becerra, and Richard Stobart. Input constraints handling in an mpc/feedback linearization scheme. *International Journal of Applied Mathematics and Computer Science*, 19(2):219–232, 2009.
- [2] Alberto Isidori. *Nonlinear control systems*. Springer, 1995.
- [3] Tadeusz Kaczorek. *Positive 1D and 2D Systems*. Springer London, 2001.
- [4] Mojtaba Kaheni, Mahdi Hadad Zarif, Ali Akbarzadeh Kalat, and Luigi Chisci. Robust feedback linearization for input-constrained nonlinear systems with matched uncertainties. In *2018 European Control Conference (ECC)*, pages 2947–2952, 2018.
- [5] Michael J. Kurtz and Michael A. Henson. Input-output linearizing control of constrained nonlinear processes. *Journal of Process Control*, 7(1):3–17, 1997.
- [6] Michael J. Kurtz and Michael A. Henson. Feedback linearizing control of discrete-time nonlinear systems with input constraints. *International Journal of Control*, 70(4):603–616, 1998.
- [7] Wiktor Malesza and Witold Respondek. *State-Linearization of Positive Nonlinear Systems; Applications to Lotka-Volterra Controlled Dynamics*, pages 451–473. John Wiley & Sons, Inc., 2013.